



**DESIGN GUIDELINES FOR THE STRENGTHENING OF  
UNREINFORCED MASONRY STRUCTURES USING GLASS GRID  
REINFORCED POLYMERS (GGRP) SYSTEMS**

Final Draft Report

Prepared for:

**BONDO  
TECHFAB**

By

**Enrico Garbin  
Nestore Galati  
Antonio Nanni**

3/3/2005

## TABLE OF CONTEXT

<b>CHAPTER 1</b>	<b>INTRODUCTION.....</b>	<b>1</b>
1.1	<i>BACKGROUND</i> .....	1
1.1.1	Masonry.....	1
1.1.2	Masonry Repair.....	1
1.1.3	FRP - Fiber Reinforced Materials.....	2
1.1.4	Objective of the Guide.....	2
1.2	<i>DEFINITIONS</i> .....	3
1.3	<i>NOTATIONS</i> .....	9
<b>CHAPTER 2</b>	<b>CONSTITUENT MATERIALS AND PROPERTIES .....</b>	<b>15</b>
2.1	<i>GENERAL DESCRIPTION</i> .....	15
2.2	<i>MATERIAL SYSTEMS</i> .....	15
2.2.1	Bondo Laminex Lexzar Polyurea Polyurea.....	15
2.2.2	TechFab Fiber Reinforcement.....	15
2.3	<i>ENGINEERING PROPERTIES</i> .....	15
2.3.1	Bondo Laminex Lexzar Polyurea.....	16
2.3.2	TechFab MeC-GRID Glass Grid.....	17
2.4	<i>PRODUCT DATA SHEETS</i> .....	17
<b>CHAPTER 3</b>	<b>SHIPPING, STORAGE, AND HANDLING .....</b>	<b>18</b>
3.1	<i>SHIPPING AND STORAGE</i> .....	18
3.2	<i>HANDLING OF MATERIALS</i> .....	18
3.2.1	Polyurea.....	18
3.2.2	Glass Fiber Grids.....	18
<b>CHAPTER 4</b>	<b>INSTALLATION.....</b>	<b>20</b>
4.1	<i>APPLICATIONS AND USE</i> .....	20
4.2	<i>INSTALLATION PROCEDURES</i> .....	20
4.2.1	Introduction.....	20
4.2.2	Installation Steps.....	21
<b>CHAPTER 5</b>	<b>INSPECTION, EVALUATION, AND ACCEPTANCE.....</b>	<b>22</b>
5.1	<i>QUALITY CONTROL AND ACCEPTANCE</i> .....	22
5.1.1	References.....	22
5.2	<i>EVALUATION AND ACCEPTANCE</i> .....	23
<b>CHAPTER 6</b>	<b>MAINTENANCE AND REPAIR .....</b>	<b>25</b>
6.1	<i>MAINTENANCE AND REPAIR</i> .....	25
<b>CHAPTER 7</b>	<b>GENERAL DESIGN CONSIDERATIONS .....</b>	<b>26</b>
7.1	<i>DESIGN PHILOSOPHY</i> .....	26
7.1.1	General considerations.....	26
7.1.2	Strength design methodology.....	28
7.2	<i>DESIGN MATERIAL PROPERTIES</i> .....	28
7.2.1	GGRP Design Material Properties.....	28
7.2.1.1	Reduction for debonding at ultimate.....	29
7.2.1.2	Reduction for creep rupture at service.....	30
7.2.2	Masonry.....	30
7.3	<i>STRENGTH REDUCTION FACTORS</i> .....	32
7.3.1	Design strength.....	32
7.3.2	Strength reduction factors.....	32
7.4	<i>SERVICEABILITY CONSIDERATIONS</i> .....	33
<b>CHAPTER 8</b>	<b>STRENGTHENING FOR OUT-OF-PLANE LOADS.....</b>	<b>34</b>
8.1	<i>GENERAL CONSIDERATIONS</i> .....	34
8.2	<i>STRENGTHENING WITH GGRP</i> .....	35
8.2.1	General assumption and considerations.....	35
8.2.2	Flexural behavior of non-load bearing walls.....	35
8.2.2.1	Failure mode.....	36
8.2.2.2	Nominal flexural capacity.....	37

8.2.3	Flexural behavior of load bearing walls .....	38
8.2.3.1	Failure mode .....	41
8.2.3.2	Nominal flexural capacity .....	41
8.2.4	Shear behavior for flexural behavior .....	42
8.3	<b>STRENGTHENING LIMITATIONS DUE TO ARCHING ACTION .....</b>	<b>44</b>
8.3.1	Design Procedure .....	46
8.3.1.1	Unstrengthened Masonry Walls .....	47
8.3.1.2	Strengthened Masonry Walls .....	48
8.3.2	Shear capacity for arching action .....	51
8.4	<b>COMPUTATION PROCEDURE .....</b>	<b>52</b>
<b>CHAPTER 9</b>	<b>STRENGTHENING FOR IN-PLANE LOADS .....</b>	<b>53</b>
9.1	<b>GENERAL CONSIDERATIONS .....</b>	<b>53</b>
9.1.1	Non-load bearing walls .....	53
9.1.2	Load bearing walls .....	54
9.1.3	Application of FRP materials for in-plane strengthening .....	55
9.1.4	Strengthening with GGRP .....	56
9.2	<b>NON-LOAD BEARING WALLS STRENGTHENED WITH GGRP SYSTEMS .....</b>	<b>57</b>
9.2.1	Nominal corner crushing strength .....	59
9.2.1.1	Computation of $P_{\phi, nC}$ for unstrengthened URM infill walls .....	59
9.2.2	Nominal shear sliding strength for strengthened walls .....	61
9.2.3	Nominal diagonal cracking strength for strengthened walls .....	62
9.3	<b>LOAD BEARING WALLS STRENGTHENED WITH GGRP SYSTEMS .....</b>	<b>63</b>
9.3.1	Nominal flexural strength .....	63
9.3.1.1	Failure mode .....	65
9.3.1.2	Nominal flexural capacity .....	65
9.3.2	Nominal shear strength .....	66
9.4	<b>SHEAR RESISTANCE PROVIDED BY THE GGRP SYSTEM .....</b>	<b>68</b>
9.5	<b>COMPUTATION PROCEDURE FOR INFILL WALLS .....</b>	<b>70</b>
9.6	<b>COMPUTATION PROCEDURE FOR SHEAR WALLS .....</b>	<b>71</b>
<b>CHAPTER 10</b>	<b>DETAILING CONSIDERATIONS .....</b>	<b>72</b>
10.1	<b>GGRP REINFORCEMENT .....</b>	<b>72</b>
10.1.1	Minimum area of GGRP reinforcement .....	72
10.1.2	Maximum spacing of GGRP reinforcement .....	72
10.2	<b>ANCORAGE LENGTH .....</b>	<b>73</b>
10.2.1	Out-of-plane .....	73
10.2.2	In-Plane .....	73
10.2.2.1	Non-Load Bearing Walls .....	73
10.2.2.2	Load Bearing Walls .....	74
10.3	<b>CONTINUITY WITH FRAME .....</b>	<b>74</b>
10.4	<b>WALLS WITH OPENING .....</b>	<b>75</b>
<b>CHAPTER 11</b>	<b>FUTURE RESEARCH .....</b>	<b>77</b>
<b>CHAPTER 12</b>	<b>REFERENCES .....</b>	<b>79</b>
12.1	<b>CITED REFERENCES .....</b>	<b>79</b>
12.2	<b>OTHER REFERENCES .....</b>	<b>81</b>
<b>APPENDIX I</b>	<b>LAMINEX LEXZAR POLYUREA HEAVY- DUTY</b>	
	<b>PROTECTIVE COATING / LINING: DATA SHEET .....</b>	<b>83</b>
A1.1	<b>PRODUCT DESCRIPTION .....</b>	<b>83</b>
A1.2	<b>CHEMICAL FORMULATION .....</b>	<b>83</b>
A1.3	<b>AVAILABLE COLORS .....</b>	<b>83</b>
A1.4	<b>FEATURES .....</b>	<b>83</b>
A1.5	<b>USES .....</b>	<b>84</b>
A1.6	<b>APPLICATION EQUIPMENT .....</b>	<b>84</b>
A1.7	<b>APPLICATION RECOMMENDATIONS .....</b>	<b>85</b>
A1.8	<b>PRODUCT PROPERTIES (MIXED MATERIAL): .....</b>	<b>85</b>
A1.9	<b>PHYSICAL PROPERTIES .....</b>	<b>86</b>

A1.10	PRODUCT SPECIFICATIONS.....	87
A1.11	CHEMICAL RESISTANCE.....	87
A1.12	DIAMONDSHEEN.....	88
A1.13	PACKAGING.....	88
A1.14	STORAGE.....	89
A1.15	BONDO SPRAY MAX: (SPRAY EQUIPMENT).....	89
A1.16	PERSONAL HEALTH SAFETY, HANDLING CHEMICALS SAFETY AND HAZARDOUS WASTE DISPOSAL.....	90
A1.17	BONDO HELP LINE.....	90
A1.18	WARRANTY.....	90

**APPENDIX II MEC-GRID STRUCTURAL REINFORCEMENT: DATA SHEET 91**

A2.1	G15000 UNIDIRECTIONAL GLASS GRID.....	91
A2.2	G4000 BALANCED GLASS GRID.....	92

**APPENDIX III BOND STRENGTH AND DEVELOPMENT LENGTH.....93**

A3.1	INTRODUCTION.....	93
A3.2	BOND STRENGTH AND DEVELOPMENT LENGTH.....	93

CONFIDENTIAL

**LIST OF FIGURES**

Figure 8-1: Internal strain and stress distribution for a horizontal rectangular section of a strip of masonry under out-of-plane loads, without axial compression..... 36

Figure 8-2: Geometric parameters of the uncracked section under out-of-plane loads with axial compression..... 39

Figure 8-3: Internal strain and stress distribution for a horizontal rectangular section of a strip of masonry under out-of-plane loads, with axial compression..... 40

Figure 8-4: Linear interpolation for determining the value of  $V_n$  when:  $0.25 < \frac{M}{V_t} < 1.0$  . 44

Figure 8-5: Comparison between Simply Supported and End-Restrained Walls..... 45

Figure 8-6: Design of Rigid Arching Walls..... 47

Figure 8-7: Half Part of Analyzed Wall..... 49

Figure 9-1: Different Failure Modes for Masonry Infilled Frames: a) Sliding Shear Mode; b) Diagonal Cracking Mode; c) Corner Crushing Mode (ACI 440, 2004)..... 54

Figure 9-2: Typical failure modes for unreinforced masonry walls, subjected to in-plane loads: a) Sliding Shear failure; b) Shear failure; c) Flexural failure (Tomažević 2000)..... 55

Figure 9-3: Geometry of infill panel..... 58

Figure 9-4: Corner crushing failure of the equivalent strut ..... 59

Figure 9-5: Sliding shear failure ..... 61

Figure 9-6: Diagonal cracking failure..... 62

Figure 9-7: Wall under in-plane loads, (a) forces acting on the wall, (b) geometric parameters of the uncracked section, (c) internal strain and stress distribution for a horizontal rectangular section..... 64

Figure 9-8: Minimum anchor length needed for shear design..... 69

Figure 10-1: Geometric dimensions for a reinforced masonry section..... 72

Figure 10-2: Minimum length of anchoring that should be assured to provide a correct shear behavior..... 73

Figure 10-3: Overlapping of the GFRP system with NSM technique to anchor the strips to the RC frame..... 74

Figure A-1: Bilinear bond stress – slip relationship ..... 94

**LIST OF TABLES**

Table 2-1: Bondo Laminex Lexzar polyurea guaranteed mechanical properties (Yu et al., 2004) ..... 16

Table 2-2: Guaranteed Mechanical Properties for TechFab’s MeC-GRID in the Longitudinal Direction..... 17

Table 2-3: Guaranteed Mechanical Properties for TechFab’s MeC-GRID in the Transverse Direction..... 17

Table 7-1: Environment Reduction Factors..... 29

Table 7-2: Stress Block Patameters  $\beta_1$  and  $\gamma$  ..... 31

CONFIDENTIAL



# CHAPTER 1 INTRODUCTION

## 1.1 BACKGROUND

### 1.1.1 Masonry

Masonry is a generic term used to describe that type of construction where a large number of small modular units are mortared together to form a structure or a component. These small units are typically concrete blocks, clay bricks, or cut stones. Load-bearing masonry is normally constructed from clay bricks or concrete blocks. Non load-bearing masonry such as partitions and veneer walls are usually constructed of bricks or cut stones, where partitions and infill walls are usually constructed of concrete blocks. Masonry has been the primary building material for almost ten millennia. The development of structural steel and reinforced concrete led to a general decline in the use of masonry. Masonry, however, re-established itself as a competitive construction material when the concept of reinforcing masonry with steel rods was applied. Attempts have been made to reinforce masonry with steel since 1825. Masonry entered the contemporary construction era one hundred years later when it was realized that reinforcing enhances the resistance of masonry structures to earthquake loads. The use of reinforcement significantly decreased the thickness of the load-bearing walls and allowed substantial increase in the number of stories in masonry buildings (ACI 440, 2004).

Clay masonry is used in such flexural applications as retaining walls, bond beams, roof and floor beams, and lintels; it is more frequently used as load-bearing walls resisting primarily compression loads. Reinforced and un-reinforced clay brick masonry has been used in constructing structural load-bearing components. In multistory buildings, clay masonry walls can serve effectively as shear walls to resist wind and earthquake loads in addition to resisting gravitational loads. Infill walls play a significant role in enhancing in-plan shear resistance of both reinforced concrete and steel frames. With the arrival of structural steel and reinforced concrete to the construction scene in addition to the production of concrete blocks, clay brick masonry was displaced to secondary construction material used primarily for veneers. Clay bricks are more frequently used as veneer where they may or may not function structurally. Clay brick veneer proved to be an excellent weather resistant cladding system. It was developed in the 1780's as cladding to wood-framed buildings. It is presently used with steel stud frames, concrete walls, as well as concrete masonry walls (ACI 440, 2004).

### 1.1.2 Masonry Repair

Un-reinforced and partially reinforced masonry structures have shown their vulnerability during major natural disasters around the world. Considering that masonry buildings of all types represent an important part of the existing building stock, significant



experimental research has been carried out in the last few decades to investigate the cause of damage and develop technologies suitable for seismic retrofit and rehabilitation of existing masonry buildings (Tomažević, 2000). These and other factors, such as change in occupancy, deterioration-related damage, or increase in lateral load demand, prompt the structural repair or retrofit of masonry buildings.

The repair and retrofit of existing masonry structures has traditionally been accomplished using conventional materials and construction techniques. Externally bonded steel plates, reinforced concrete overlays, grouted cell reinforcements, and external post-tensioning are just some of the many traditional techniques available (ACI 440, 2004). Next to these the emerging technique of applying FRP (Fiber Reinforced Polymer) materials onto civil structures has grown in the last decade.

### **1.1.3 FRP - Fiber Reinforced Materials**

Advanced composite materials made of fibers in a polymeric matrix, also known as Fiber Reinforced Polymers (FRP) composites, have emerged as an alternative to traditional materials and techniques (Nanni, 2003). FRP materials are lightweight, non-corrosive, and exhibit high tensile strength and modulus, impact resistance and electromagnetic permeability. Additionally, these materials are readily available in several forms, including factory-made precured, wet-layup, and prepreg systems, reinforcing bars and prestressing tendons. Currently, FRP composite materials are primarily applied to masonry shear, load bearing and infill walls as surface mounted, near surface embedded or un-bonded applications. FRP systems can provide seismic, wind or blast strengthening of un-reinforced or reinforced concrete or clay masonry structural elements. Furthermore, FRP composites are also applicable as reinforcing for new construction (ACI 440, 2004).

The growing interest in FRP systems for repair and retrofit can be attributed to many factors. Although the fibers and resins used in FRP systems are relatively expensive compared with traditional strengthening materials like concrete and steel, labor and equipment costs to install FRP systems are often lower. FRP systems can also be used in areas with limited access where traditional techniques would be very impractical. FRP systems can have lower life-cycle costs than conventional strengthening techniques because the FRP system is less prone to corrosion. Additionally, FRP systems do not add a significant weight to the structure, and have minimal aesthetic impact on the structure (ACI 440M, 2004).

### **1.1.4 Objective of the Guide**

This guide is for the design and construction of externally bonded glass FRP grids. In this instance the FRP system consists of glass unidirectional reinforcement grid (provided by Tech Fab, [www.techfabllc.com](http://www.techfabllc.com)) and polyurea resin (provided by Bondo,

[www.bondo.com](http://www.bondo.com)) to create a composite laminate, herein called GGRP (Glass Grid Reinforced Polymer).

Polyurea is a unique class of polymer defined as the reaction of isocyanate and blend of primary and secondary amine terminated polyols. Polyurea combines desirable application properties, such as rapid cure and insensitivity to humidity, with good physical properties, including high hardness, flexibility, tear and tensile strength. The polyurea spray coating technique has been introduced in various areas, most predominantly corrosion protection and retrofit of reinforced concrete (RC) members. This GGRP product is an effective technique to strengthen un-reinforced masonry walls. The walls strengthened by means of grid reinforced polyurea have a good in-plane capacity and a great post-failure strength (Yu et al., 2004). Additional research is in progress to fully characterize the mechanical parameters defining this special glass FRP product.

This document provides information on selection, design philosophy, design and installation of GGRP systems used to repair or retrofit masonry structures. Information on material properties, quality control, maintenance, and field applications of this FRP system is presented. This information can be used to select a GGRP system to increase in-plane and out-of-plane strengths and stiffness of un-reinforced masonry walls. In this design guideline, coatings used exclusively for aesthetic reasons are not considered part of the GGRP system.

This design guide tries to condense much of the current literature and take into account the recommendations from existing guides in draft or published forms in order to provide owner, engineer, contractor and inspector with a useful design reference. Through periodic updates the guide will reflect the most current research on externally bonded FRP reinforcement.

Additional information is available at [www.bondo.com](http://www.bondo.com) and [www.techfabllc.com](http://www.techfabllc.com).

## 1.2 DEFINITIONS

- A -

**Area, gross cross-section** - The area delineated by the out-to-out dimensions of masonry in the plane under consideration.

**Area, net cross-section** - The area of masonry units, grout, and mortar crossed by the plane under consideration based on out-to-out dimensions.

- B -

**Balanced reinforcement ratio** - The reinforcement ratio in a flexural member that causes the effective design strain of GGRP and the ultimate compressive strain of masonry to be simultaneously attained.

**Bed joint** - The horizontal layer of mortar on which a masonry unit is laid.

- C -

**Composite** - A combination of one or more materials differing in form or composition on a macroscale.

**Compressive strength of masonry** - Maximum compressive force resisted per unit of net cross-sectional area of masonry, determined by testing masonry prisms or a function of individual masonry units, mortar, and grout, in accordance with the provision of ACI 530.1/ASCE 6-02/TMS 602.

**Creep rupture** - The gradual, time-dependent reduction of tensile strength due to continuous loading that leads to failure of the section.

**Cross-link** - A chemical bond between polymer molecules. Note that an increased number of cross-link per polymer molecule increase strength and modulus at the expense of ductility.

**Cure of a thermoset** - The process of causing the irreversible change in the properties of a thermosetting resin by chemical reaction. Cure is typically accomplished by addition of curing (cross linking) agents or initiators. Full cure is the point at which a resin reaches the specific properties. Undercure is a condition where specified properties have not been reached.

- D -

**Debonding** - A separation at the interface between the substrate and the adherent material.

**Degradation** - A decline in the quality of the mechanical properties of a material.

**Delamination** - A separation along a plane parallel to the surface, as in the separation of the layers of the GGRP system from each other.

**Depth** - The dimension of a member measured in the plane of a cross section perpendicular to the neutral axis.

**Design strength** - The nominal strength of an element multiplied by the appropriate strength reduction factor.

**Development length** - The bonded distance required for transfer of stresses from the masonry to the GGRP so as to develop the strength of the GGRP system. The development length is a function of the strength of the substrate and the rigidity of the bonded GGRP.

- E -

**Effective height** - Clear height of a braced member between lateral supports and used for calculating the slenderness ratio of a member. Effective height for unbraced members shall be calculated.

**Epoxy** - A thermosetting polymer that is the reaction product of epoxy resin and an amino hardener. It is also a class of organic chemical bonding systems used in the preparation of special coatings or adhesives for masonry as binders in epoxy resin mortars.

- F -

**Fatigue strength** - The greatest stress that can be sustained for a given number of load cycles without failure.

**Fiber** - Any fine thread-like natural or synthetic object of mineral or organic origin.

**Fiber content** - The amount of fiber present in a composite. This usually is expressed as a percentage volume fraction or weight fraction of the composite.

**Fiber, glass** - Fiber drawn from an inorganic product of fusion that has cooled without crystallizing.

**Fiber Reinforced Polymer (FRP)** - Composite material consisting of continuous fibers impregnated with a fiber-binding polymer then molded and hardened in the intended shape.

**Fiber volume fraction** - The ratio of the volume of fibers to the volume of the composite.

**Fiber weight fraction** - The ratio of the weight of fibers to the weight of the composite.

- G -

**GGRP** - Glass grid reinforced polymer.

**Glass fiber** - An individual filament made by drawing or spinning molten glass through a fine orifice. A continuous filament is a single glass fiber of great or indefinite length.

**Glass transition temperature ( $T_g$ )** - The midpoint of the temperature range over which an amorphous material (such as glass or a high polymer) change from (or to) a brittle, vitreous state to (or from) a plastic state.

**Grid** - A two dimensional array of fibers with one principal direction and the second useful only to braid the fibers. This array can be use to unidirectionally reinforce polymers.

- H -

**Hardener** - The chemical component in a two-component adhesive or coating that causes the resin component to cure.

**Head joint** - Vertical mortar joint placed between masonry units within the wythe at the time the masonry units are laid.

**Height** - The vertical dimension of the wall.

- I -

**Impregnate** - In fiber-reinforced polymer, to saturate the fibers with resin.

**Interface** - The boundary or surface between two different, physically distinguishable media.

- L -

**Laminate** - One or more layers of fiber bounding together in cured resin matrix.

**Load, dead** - Dead weight supported by a member, as defined by the legally adopted building code.

**Load, live** - Live load specified by the legally adopted building code.

**Load, service** - Load specified by the legally adopted building code.

- M -

**Masonry substrate** - The existing masonry or any repair material used to repair or replace the existing masonry. The substrate can consist entirely of existing masonry, or of a combination of exiting masonry and repaired materials. The substrate includes the surface to which the GGRP system is installed.

**Matrix** - In the case of fiber reinforced polymer system, the material that binds fibers together, transfers loads to the fibers, and protects them against environmental attack and damage due to handling.

**Modulus of elasticity** - Ratio of normal stress to corresponding strain for tensile or compressive stresses below proportional limit of material.

**Modulus of rigidity** - Ratio of unit shear stress to unit shear strain for unit shear stress below the proportional limit of material.

**Monomer** - An organic molecule of relatively low molecular weight that creates a solid polymer by reacting with itself or other compounds of low molecular weight or both.

- N -

**Nominal strength** - The strength of an element or cross section calculated in accordance with the requirements and assumptions of the strength design methods of these provisions before application of strength reduction factor.

- O -

**Out-of-plane wall** - A wall, bearing or nonbearing, designed to resist lateral forces acting perpendicularly to the plane of the wall.

- P -

**Polymer** - A high molecular weight organic compound, natural or synthetic, containing repeating units.

**Polymerization** - The reaction in which two or more molecules of the same substance combine to form a compound containing the same elements and in the same proportions but of higher molecular weight.

**Polyurea** - Class of polymer defined as the reaction of isocyanate and blend of primary and secondary amine terminated polyols.

- R -

**Reinforcement** – Non prestressed GGRP reinforcement.

**Required strength** - The strength needing to resist factored loads.

**Resin** - Polymeric material that is rigid or semirigid at room temperature, usually with a melting point or glass transition temperature above room temperature.

**Resin content** - The amount of resin expressed as either a percentage of total mass or total volume.

- S -

**Shear wall** - A wall, bearing or nonbearing, designed to resist lateral forces acting in the plane of the wall.

**Shelf life** - The length of time packaged materials can be stored under specified conditions and remain usable.

- T -

**Thermoset** - Resin that is formed by cross-linking polymer chains. A thermoset cannot be melted and recycled because the polymer chains form a three dimensional network.

- U -

**Unreinforced masonry** - Masonry in which the tensile resistance of masonry is taken into consideration and the resistance of the reinforcement is neglected.

- V -

**VOC** - Volatile organic compounds; any compound of carbon, excluding carbon monoxide, carbon dioxide, carbonic acid, metallic carbides or carbonates, and ammonium carbonate, that participate in atmospheric photochemical reactions such as ozone depletion.

**Volume fraction** - The proportion from 0.0 to 1.0 of a component within the composite, measured on a volume basis, such as fiber-volume fraction.

- W -

**Wall** - A vertical element with a horizontal length to thickness ratio greater than 3, used to enclose space.

**Width** - The dimension of a member measured in the plane of cross section parallel to the neutral axis.

**Wythe** - Each continuous vertical section of a wall, one masonry unit in thickness.

### 1.3 NOTATIONS

$a$	=	depth of equivalent rectangular stress block, (in).
$a_c$	=	arm distance between clamping forces, (in).
$a_f$	=	arm distance between force in FRP and clamping force at mid-height, (in).
$b$	=	width of rectangular cross section, (in).
$b_1$	=	bearing width at top, (in).
$b_2$	=	bearing width at mid-height, (in).
$c$	=	distance from extreme compression fiber to the neutral axis, (in).
$c_b$	=	distance from extreme compression fiber to neutral axis at balanced strain condition, (in).
$d$	=	distance from extreme compression fiber to centroid of tension reinforcement, (in).
$f_{bt}$	=	tensile strength of the blocks or bricks, (psi).
$f_f$	=	stress in the GGRP reinforcement in tension, (psi).
$f_{fe}$	=	effective design tensile stress of GGRP, considering the reduction factor $k_m$ for flexural debonding, (psi).
$f_{fe,\omega}$	=	effective design tensile stress of GGRP, considering the reduction factor $k_{v,\omega}$ for shear debonding, (psi).
$f_{f,s}$	=	stress level in the GGRP caused by sustained loads, (psi).
$f_{fu}^*$	=	guaranteed tensile strength of GGRP, defined as the mean tensile strength of a sample of test specimens minus three times the standard deviation ( $f_{fu}^* = f_{fu,ave} - 3\sigma$ ), (psi).
$f_{fu}$	=	design tensile strength of GGRP, considering reduction for service environment, (psi).
$f_{fu,ave}$	=	mean tensile strength at rupture of a sample of test specimens (psi).
$f_m'$	=	specified compressive stress of masonry, (psi).



- $f'_{m-0}$  = specified compressive strength of the masonry wall parallel to the bed joint, (psi).
- $f'_{m-\phi}$  = ultimate compressive strength of the equivalent strut for infill walls, (psi).
- $h$  = effective height of wall, (in).
- $k_m$  = debonding reduction factor.
- $l_b$  = unbonded length (in).
- $n$  = number of plies.
- $p$  = mean vertical stress, (psi).
- $q_n$  = nominal lateral strength for uniform loads, (lb/ft).
- $q_u$  = factored lateral load for uniform loads, (lb/ft).
- $r$  = radius of gyration, (in).
- $t$  = thickness of the masonry, (in).
- $t_f$  = nominal thickness of one ply of the GGRP reinforcement, (in).
- $w_f$  = width of the GGRP reinforcing plies, (in).
- $w_m$  = width of the wall, (in).
- $A_f$  = area of GGRP reinforcement, (in<sup>2</sup>).
- $A_n$  = net cross-section area of masonry, (in<sup>2</sup>).
- $A_\phi$  = area of the equivalent strut for infill walls, (in<sup>2</sup>).
- $C_E$  = environment reduction factor based on type of fiber and exposure conditions.
- $C_1$  = clamping forces at top of the wall, (lb).
- $C_2$  = clamping forces at mid-height of the wall, (lb).
- $D$  = dead load or related internal moments and forces.
- $E_m$  = modulus of elasticity of masonry, (psi).

- $E_f$  = guaranteed modulus of elasticity of GGRP defined as the mean modulus of a sample of test specimens ( $E_f = E_{f,ave}$ ), (psi).
- $E_{f,ave}$  = mean modulus of a sample of test specimens, (psi).
- $E_\phi$  = modulus of elasticity of the equivalent strut for infill walls, (psi).
- G = center of mass.
- $H_n$  = nominal lateral strength for concentrated loads, (lb).
- $H_u$  = factored lateral load for concentrated loads, (lb).
- $K_\phi$  = axial stiffness of the equivalent strut, (lb/in).
- L = live load or related internal moments and forces.
- $L_\phi$  = length of the equivalent strut for infill walls, (in).
- M = Maximum moment at the section under consideration, (in-lb).
- $M_n$  = nominal moment capacity, (lb-in).
- $M_{pj}$  = minimum of the plastic moment capacity of the column, the beam or the connection, referred to as the plastic moment capacity of the joint, (lb-in).
- $M_{pc}$  = column plastic moment capacity, (lb-in).
- $M_u$  = factored moment at section, (lb-in).
- P = axial load, (lb).
- $P_n$  = nominal axial strength, (lb).
- $P_u$  = factored axial load, (lb).
- $P_{\phi,nc}$  = strength of the equivalent strut for infill walls relate to corner crushing failure, (lb).
- $R_{nC}$  = strength nominal capacity related to corner crushing failure, (lb).
- $R_{nD}$  = strength nominal capacity related to diagonal cracking failure, (lb).
- $R_{nS}$  = strength nominal capacity related to sliding shear failure, (lb).
- $R_u$  = ultimate horizontal lateral load for infill walls, (lb).

- $S_n$  = generic nominal capacity.  
 $U_u$  = generic required strength.  
 $S_s$  = shear stress determined in accordance with ASTM E519-02, (psi).  
 $T_f$  = axial force in the GGRP laminate, (lb).  
 $V$  = shear force, (lb).  
 $V_m$  = shear strength provided by masonry, (lb).  
 $V_{m,D}$  = masonry shear capacity for a diagonal cracking failure, (lb).  
 $V_{m,f}$  = shear capacity provided by GGRP system, (lb).  
 $V_{m,s}$  = masonry shear capacity for a sliding failure, (lb).  
 $V_n$  = nominal shear strength, (lb).  
 $V_u$  = factored shear at section, (lb).  
  
 $\alpha$  = ratio between the modulus of elasticity and the specified compressive stress of masonry.  
 $\alpha_c$  = ratio of the column contact length to the clear column height  $h$ .  
 $\beta_1$  = reduction factor applied to the depth of the neutral axis, to define the rectangular stress block.  
 $\delta_1$  = crack opening at top in correspondence of the wall axis, (in).  
 $\delta_2$  = crack opening at mid-height of the wall axis, (in).  
 $\Delta_1$  = total shortening of interior masonry fiber in compression, (in).  
 $\Delta_2$  = total shortening of exterior masonry fiber in compression, (in).  
 $\Delta_o$  = mid-height deflection, (in).  
 $\varepsilon_f$  = strain in GGRP reinforcement (in/in).

$\epsilon_{fe}$	=	effective design strain of GGRP, considering reduction for debonding, (in/in).
$\epsilon_{fu}^*$	=	guaranteed rupture strain of GGRP reinforcement defined as the mean tensile strain at the failure of a sample of test specimens minus three times the standard deviation ( $\epsilon_{fu}^* = \epsilon_{fu,ave} - 3\sigma$ ), (in/in).
$\epsilon_{fu}$	=	design strain of GGRP, considering reduction for service environment, (in/in).
$\epsilon_{fu,ave}$	=	mean strain at rupture of a sample of test specimens (in/in).
$\epsilon_m$	=	strain in masonry, (in/in).
$\epsilon_m'$	=	Strain level in the masonry corresponding to the peak value of stress $f_m'$ , (in/in).
$\epsilon_{mu}$	=	ultimate strain in masonry.
$\phi$	=	strength reduction factor.
$\gamma$	=	reduction factor applied to $f_m'$ , to define the rectangular stress block.
$\varphi$	=	inclination of the equivalent strut for infill walls, (degree, °)
$\mu$	=	coefficient of friction.
$\theta$	=	rotation of the wall, (radian).
$\Theta_f$	=	GGRP reinforcement ratio for in-plane walls.
$\Theta_{fb}$	=	GGRP reinforcement ratio producing balanced strain condition for in-plane walls.
$\rho_f$	=	GGRP reinforcement ratio for out-of-plane walls.
$\rho_{fb}$	=	GGRP reinforcement ratio producing balanced strain condition for out-of-plane walls.
$\sigma$	=	standard deviation.
$\tau_0$	=	cohesive strength at the bed joint, (psi).
$\tau_{c,s}$	=	shear stress relevant to the cracked section for diagonal cracking associated with mortar bed and head joint failure, (psi).
$\tau_u$	=	Ultimate mean shear stress, (psi).

$\tau_{v,S}$  = shear stress related to diagonal cracking associated with mortar bed and head joint failure, (psi).

$\tau_{v,D}$  = shear stress related to diagonal cracking associated with the splitting of the concrete blocks or tile bricks, (psi).

$\tau_{w,S}$  = shear stress relevant to the whole section for diagonal cracking associated with mortar bed and head joint failure, (psi).

CONFIDENTIAL

## **CHAPTER 2     CONSTITUENT MATERIALS AND PROPERTIES**

### **2.1   GENERAL DESCRIPTION**

The Bondo-TechFab Strengthening System is used to increase the strength capacity of existing masonry structures. This product offers excellent performance and installation advantages over other types of FRP systems. It is comprised of two basic components that when combined, form a high strength FPR laminate. A glass fiber grid by TechFab provides strengthening. The grid is bonded by the use of polyurea produced by Bondo. The components of the Bondo TechFab GGRP system are described below.

### **2.2   MATERIAL SYSTEMS**

#### **2.2.1   Bondo Laminex Lexzar Polyurea Polyurea**

Polyurea is a unique class of polymer defined as the reaction of an isocryante prepolymer and a blend of primary and secondary amine terminated polols. Bondo's Laminex Lexzar Polyurea coating has been formulated to combine desirable application properties, such as rapid cure and insensitivity to humidity, with good physical properties, including high hardness and flexibility. The polyurea is applied as a spray coating and cures rapidly, making application simple and fast. It is first sprayed directly onto the masonry surface, and than sprayed again on the glass grid to completely cover and bond the grid to the substrate.

#### **2.2.2   TechFab Fiber Reinforcement**

High strength, unidirectional fiber reinforcement is the structural backbone of the GGRP system. TechFab's MeC-GRID G15000 and G4000 E-glass grids are typically used. The grid has a high strength to weight ratio and it is easy to fabricate and cut to length.

### **2.3   ENGINEERING PROPERTIES**

The tensile properties of polyurea and GFRP grid should be obtained from the manufacturers. Usually, a normal (Gaussian) distribution is assumed to represent the strength of a population of bar specimens; although, at this time additional research is

needed to determine the most generally appropriate distribution for FRP bars. Manufacturers should report a guaranteed tensile strength,  $f_{fu}^*$ , defined by this guide as the mean tensile strength of a sample of test specimens minus three times the standard deviation ( $f_{fu}^* = f_{fu,ave} - 3\sigma$ ), and similarly report a guaranteed rupture strain,  $\varepsilon_{fu}^*$  ( $\varepsilon_{fu}^* = \varepsilon_{fu,ave} - 3\sigma$ ) and a specified tensile modulus,  $E_f = E_{f,ave}$ ). These guaranteed values of strength and strain provide a 99.87% probability that the indicated values are exceeded by similar FRP bars, provided at least 25 specimens are tested (Dally and Riley 1991; Mutsuyoshi, Uehara, and Machida 1990). If less specimens are tested or a different distribution is used, texts and manuals on statistical analysis should be consulted to determine the confidence level of the distribution parameters (MIL-17 1999). In any case, the manufacturer should provide a description of the method used to obtain the reported tensile properties.

### 2.3.1 Bondo Laminex Lexzar Polyurea

This section is presented to acquaint the user to the physical appearance and handling properties of Bondo Laminex Lexzar polyurea. In general, the polyurea is easy to mix and apply. It is formulated to provide adequate time for application, yet a rapid cure time.

With regard to the design assumption that bond between the composite and masonry substrate is “perfect”, it is necessary for all materials within the bond line to be stronger and more resilient than the masonry substrate. For this reason, the tensile, compressive and flexural properties of the neat resin are presented. The term “neat resin” refers to a sample of cured resin with no reinforcing fiber materials present. Because of the viscoelastic behavior of polyurea, the temperature and strain rate during testing are important parameters that greatly influence the strength and stiffness of the materials. Therefore, to provide repeatable results, testing is performed according to appropriate ASTM standards.

Bondo Polyurea has the following guaranteed mechanical properties (ASTM D638):

**Table 2-1: Bondo Laminex Lexzar polyurea guaranteed mechanical properties (Yu et al., 2004)**

	Tensile strength (ksi)	Elastic modulus (ksi)	Ultimate strain (in./in.)
Average	0.7	26	0.419

### 2.3.2 TechFab MeC-GRID Glass Grid

The overall engineering or mechanical properties of the GGRP system are greatly influenced by the fiber grid. For typical design purposes, only the tensile strength and tensile modulus of the grid are considered expressed in terms of fiber volume. These values are determined by tensile testing of FRP fiber grids without polyurea. The stress-strain curve for the TechFab grids are typical of FRP and show linear behavior up to ultimate stress followed by brittle failure.

Guaranteed material properties for the TechFab MeC-GRID glass grid are summarized in Table 2-2 and Table 2-3 for longitudinal and transverse direction, respectively. It has to be noted that some of the mechanical properties are missing since additional tests are necessary to characterize the material.

**Table 2-2: Guaranteed Mechanical Properties for TechFab’s MeC-GRID in the Longitudinal Direction**

MeC-GRID	Grid Spacing (in)	Tensile Strength (lbs/ft) (warp x fill)	Cross Sectional Area (in <sup>2</sup> /ft)	Tensile strength (ksi) (warp x fill)	Elastic modulus (ksi) (warp x fill)	Ultimate strain (in./in.) (warp x fill)
G15000-BX1	0.437 <sup>1</sup>	14,400 <sup>1</sup>	0.180 <sup>2</sup>	64.5 <sup>2</sup>	5306 <sup>2</sup>	0.012 <sup>2</sup>
G4000-BX1	0.3 <sup>1</sup>	6,600 <sup>1</sup>	--	--	--	--

<sup>(1)</sup>Data provided by TechFab

<sup>(2)</sup>Based on the experimental results obtained by Yu et al., 2004

**Table 2-3: Guaranteed Mechanical Properties for TechFab’s MeC-GRID in the Transverse Direction**

MeC-GRID	Grid Spacing (in)	Tensile Strength (lbs/ft) (warp x fill)	Cross Sectional Area (in <sup>2</sup> /ft)	Tensile strength (ksi) (warp x fill)	Elastic modulus (ksi) (warp x fill)	Ultimate strain (in./in.) (warp x fill)
G15000-BX1	0.281 <sup>1</sup>	1,870 <sup>1</sup>	--	--	--	--
G4000-BX1	0.4 <sup>1</sup>	4,800 <sup>1</sup>	--	--	--	--

<sup>(1)</sup>Data provided by TechFab

## 2.4 PRODUCT DATA SHEETS

Data sheets for the Bondo polyurea and TechFab glass grids are presented in Appendix I and Appendix II, respectively.



## **CHAPTER 3 SHIPPING, STORAGE, AND HANDLING**

### **3.1 SHIPPING AND STORAGE**

All materials shall be delivered in “new” condition only, packaged in their original, unopened containers bearing the manufacturer’s name, product identification, batch number(s), and shelf life expiration date.

All materials shall be stored in a covered, well-ventilated area and protected from exposure to any detrimental conditions including, airborne contaminants, dirt, dust, sunlight, extreme cold, heat, rainfall, sparks, or flame.

### **3.2 HANDLING OF MATERIALS**

#### **3.2.1 Polyurea**

While the Bondo polyurea is formulated with the applicator in mind, some people may be sensitive to the resins and curing agents contained within. As with most chemicals, proper ventilation, as well as eye and skin protection should be provided. Material Data Safety Sheets (MSDS) are always provided with each shipment of the polyurea. These should be kept on file at the job-site and referred to in case of an accident.

#### **3.2.2 Glass Fiber Grids**

The reinforcing glass grid is susceptible to surface damage. Puncturing the surface of one of the bars in the grid can significantly reduce the strength of that bar, therefore weakening the grid. And because the bars are glass, the surface damage can cause a loss of durability due to infiltration of alkalis. The following handling guidelines are recommended to minimize damage to both the grid and the grid handlers:

- GGRP reinforcing grids should be handled with work gloves to avoid personal injuries from either exposed fibers or sharp edges;
- GGRP reinforcing grids should not be stored on the ground. Pallets should be placed under the grids to keep them clean and to provide easy handling;
- High temperatures, ultraviolet rays, and chemical substances should be avoided because they can damage the glass grid;

- When necessary, cutting should be performed with a high-speed grinding cutter or a fine-blade saw. GGRP reinforcing grids should never be sheared. Dust masks, gloves, and glasses for eye protection are recommended when cutting. There is insufficient research available to make any recommendation on treatment of saw-cut grid ends.

CONFIDENTIAL

## **CHAPTER 4      INSTALLATION**

### **4.1    APPLICATIONS AND USE**

The Bondo-TechFab GGRP Strengthening System was developed as a cost-effective alternate to conventional strengthening techniques. The high strength GGRP can be installed quickly and easily on masonry surfaces. The system has been used to increase of out-of-plane and in-plane capacity of masonry walls.

### **4.2    INSTALLATION PROCEDURES**

#### **4.2.1    Introduction**

Bond is a key factor that determines efficiency of GGRP strengthening. As a result, measures to guarantee the required degree of bond quality are emphasized in available guide documents on strengthening using FRP. Unsuitable ambient conditions may easily spoil the whole retrofit job. At the time of application, temperature and humidity should conform to the recommendations and specifications provided by the manufacturer (ACI440, 2004).

Once the adequate GGRP system has been selected and designed for the repair or retrofit project, the masonry surface to which the GGRP system is to be applied to should then be prepared. Surface preparation has a significant impact on bond, because it is necessary in order to adequately transfer the forces between masonry elements and surface bonded GGRP composite overlays. This preparation consists of complete removal of all laitance, dust, dirt, oil, curing compound, existing paint or coatings, and efflorescence from the masonry surface (ACI440, 2004).

For unspoiled new clay or concrete masonry surfaces, wire brushing has proved to be adequate to remove any loose particles or dust. However, the surface preparation of older clay or concrete masonry structural members should consist of more forceful techniques, such as water blasting, and grinding or wire brushing with power tools. Concrete masonry units may also be lightly sand blasted, but this method should not be used for clay units, for which, sand blasting may cause clay surface damage (ACI 440, 2004).

GGRP strips shall not be applied to concave surfaces. Under tension, FRP reinforcement will peel-off of the concave surface, which may initiate complete debonding. Convex surfaces, on the other hand, do not cause any harm. The soundness of the substrate the FRP reinforcement will be adhered to is very important. Premature failure may take place through the substrate, if its bond strength is below a required minimum value (ACI 440, 2004).

#### 4.2.2 Installation Steps

The GGRP strengthening system can easily be installed on properly prepared, sound masonry surfaces in a series of four steps. This process can be repeated with more than one glass grid if necessary. The basic process involves using the polyurea to impregnate the fiber grid to form the glass fiber grid reinforced polymer laminate.

No holes should be cut in the grid to circumvent obstacles such as pipes, hangers, and drain holes. The grid must be split to avoid these obstacles.

- **Step 1: Preparation of the concrete substrate**

The integrity of the system depends on the bond between GGRP and the masonry surface. In most cases, the masonry walls do not require much preparation, other than making sure the surface is clean and dry. The application of primer or putty is not necessary. The surface of the wall should be free of loose and unsound materials. A suitable repair mortar or epoxy paste may be used to patch required areas.

- **Step 2: Application of first coat polyurea**

The polyurea is sprayed onto the prepared masonry surface. Surrounding areas of the walls that are not going to have the GGRP applied can be covered with thick plastic sheets to keep the polyurea confined to the desired surfaces.

- **Step 3: Application of glass grid**

The fiber grids should be measured and pre-cut prior to installing on the surface. The grid needs to be applied immediately after the first coat of polyurea has been sprayed onto the surface as the polyurea will cure within minutes of application. The grid is placed on the masonry surface and gently pressed into the polyurea.

- **Step 4: Application of second coat of polyurea**

The polyurea is sprayed again over the fiber grid to completely coat the grid and bond it to the masonry substrate. A finishing product can be used after the second coat has completely cured if so desired.

## CHAPTER 5 INSPECTION, EVALUATION, AND ACCEPTANCE

### 5.1 QUALITY CONTROL AND ACCEPTANCE

Quality control should be carried out by lot testing of the GGRP constituent. Tests conducted by manufacturer or a third-party independent testing agency can be used.

All tests should be performed using the recommended test methods cited in this manual. Material characterization tests that include the following properties should be performed at least once before and after any change in manufacturing process, procedure, or materials:

- Tensile strength, tensile modulus of elasticity, and ultimate strain;
- Fatigue strength;
- Bond strength; and
- Coefficient of thermal expansion.

To assess quality control of an individual lot of glass grids, it is recommended to determine tensile strength, tensile modulus of elasticity, and ultimate strain. TechFab should furnish upon request a certificate of conformance for any given lot of the glass grids with a description of the test protocol.

The glass grid shall be aligned on the structural member according to the Contract Documents. Any deviation in the alignment more than 5° (approximately 1 in/ft) is not acceptable. Once installed, the fibers shall be free of kink, folds and waviness.

#### 5.1.1 References

The publications listed below form a part of this specification to the extent referenced. The publications are referred to within the text by the basic designation only.

#### AMERICAN SOCIETY FOR TESTING AND MATERIALS (ASTM)

ASTM C 882	Standard Test Method for Bond Strength of Epoxy-Resin Systems Used with Concrete by Slant Shear
ASTM D 638	Standard Test Method for Tensile Properties of Plastics
ASTM D 695	Standard Test Method for Compressive Properties of Rigid Plastics
ASTM D3039	Standard Test Method for Tensile Properties of Polymer Matrix Composite Materials
ASTM D 3171	Standard Test Method for Fiber Content of Resin-Matrix Composites by Matrix Digestion
ASTM D 3379	Standard Test Method for Tensile Strength and Young's Modulus

- ASTM D 4258 for High-Modulus Single-Filament Materials  
Standard Practice for Surface Cleaning Concrete for Coating.  
ASTM D 4541 Standard Test Method for Pull-Off Strength of Coatings Using  
Portable Adhesion Testers

**AMERICAN CONCRETE INSTITUTE (ACI)**

- ACI 515.1R A Guide to the Use of Waterproofing, Damp proofing, Protective,  
and Decorative Barrier systems for Concrete.  
ACI 440.1R-02 Guide for the Design and Construction of Concrete Reinforced with  
FRP Bars  
ACI 440.2R-02 Guide for the Design and Construction of Externally Bonded FRP  
Systems for Strengthening Concrete Structures

**NATIONAL ASSOCIATION OF CORROSION ENGINEERS (NACE)**

- NACE RP 0288 Inspection of Linings on Steel and Concrete

**INTERNATIONAL CONCRETE REPAIR INSTITUTE**

- Guideline No. Selecting and Specifying Concrete Surface Preparation for Sealers,  
03732 Coatings, and Polymer Overlays

**STEEL STRUCTURES PAINTING COUNCIL (SSPC)**

- SSPC-PA A Guide to Safety in Paint Application.  
Guide 3

**5.2 EVALUATION AND ACCEPTANCE**

The Contractor shall review the requirements of the Specification and overall project requirements. All aspects of the project including containment, environmental control, surface preparation, strengthening system application, quality assurance, schedule requirements, and safety shall be reviewed and discussed. The Contractor shall request clarification of any ambiguities, and advise the Engineer of any potential conflicts and/or any technical requirements that appear improper or inappropriate.

The Contractor shall ensure the highest quality of workmanship at all times throughout the progression of the work. Only qualified installers having prior training in the specified surface preparation and in fiber reinforced polymer applications shall be assigned to perform the work described herein.

The Contractor shall provide full an inspection of the surface preparation and the composite systems application to ensure that all requirements are in full compliance. The installed GGRP system shall be completely free of laminate defects including voids, unsaturated areas, and inclusions. After the installed system has been allowed to cure a minimum of 24 hours, the Contractor shall repair all defects as necessary.

Direct tension adhesion testing of cored samples should be conducted as described in ASTM D4541. A minimum of three tests should be performed for each day of production or for each 500 ft<sup>2</sup> of GGRP system application, whichever is less. Pull-off tests (ASTM C-1583 04) should be performed on each area of five strips installed on a single day. Tests should be performed on each type of masonry substrate or for each surface preparation technique used (ACI 440, 2004).

The GGRP system should be allowed to cure before execution of the direct tension pull-off test. The locations of the pull-off tests should be representative and on flat surfaces. If possible, the tests should be conducted on areas of the GGRP system subjected to relatively low stress during service. The minimum acceptable value for any single tension test should not be lower than 130 - 175 psi. The average of the three tests at each location shall not be less than 200 psi. Additional tests may be performed to qualify the work (e.g. : direct shear tests performed in qualified laboratory, sound and ultrasound tests, acoustic emission, active thermography). The tension adhesion tests should exhibit failure of the masonry substrate indicated by a layer of masonry on the underside of the test puck following the test (ACI 440, 2004, CNR DT, 2004).

CONFIDENTIAL

## **CHAPTER 6      MAINTENANCE AND REPAIR**

### **6.1    MAINTENANCE AND REPAIR**

Soundings of the strengthened areas will be done to check for voids, bubbles and delaminations. All voids, bubbles, and delaminations shall be repaired by polyurea replacement.

Applied GGRP systems that are found to be defective or damaged will be replaced if deemed necessary by the Engineer. Rework and repair procedures shall comply with all material and procedural requirements defined in this manual. Defects shall be repaired in a manner that will restore the system to the designed level of quality. All repairs shall be made to the satisfaction of Engineer.

CONFIDENTIAL



## CHAPTER 7 GENERAL DESIGN CONSIDERATIONS

Externally bonded FRP reinforcement is an efficient technique that can be applied for a wide range of structures and materials. This guideline relates to the design of masonry structures strengthened with Glass Grid Reinforced Polyurea (GGRP) systems.

GGRP systems can be used to: a) rehabilitate or restore the strength of a weakened structural element; b) retrofit or strengthen a sound structural element to resist increased loads due to changes in use; and, c) address design or construction errors (ACI 440M, 2004). The engineer should determine whether the GGRP is an appropriate strengthening technique before employing it.

The design of bonded GGRP systems to out-of-plane and in-plane loads is based on principles of equilibrium and compatibility and the constitutive laws of the materials. Both GGRP and masonry show a brittle behavior, that allow considering, as failure control mechanism, either GGRP rupture/debonding or masonry crushing. Masonry strengthened with FRP systems typically fails due to crushing of the masonry (Triantafillou, 1998) or debonding of the FRP (Hamilton et al., 2001, Valluzzi et al., 2002).

### 7.1 DESIGN PHILOSOPHY

#### 7.1.1 General considerations

The design should address all relevant limit states. The design of the GGRP systems has to reflect the effects of the additional reinforcement provided to the member and the ability of transferring forces by mean of the bond interface. Design calculations are based on analytical or semi-empirical models.

The state of the structure prior to strengthening should be taken as a reference for the design of the GGRP reinforcement. As the application of the GGRP system is not intended to confine or arrest defects, possible damage or deterioration is to be identified and causes of deficiencies should be known. If needed, correct repair should be undertaken to assure a proper behavior of the masonry member (Fib 14, 2001).

To assess the suitability of a GGRP system for a particular application, the engineer should evaluate the existing structure to establish its existing load-carrying capacity, identify deficiencies and their causes, and determine the condition of the masonry substrate. The overall evaluation should include a thorough field inspection, review of existing design or as-built documents, and a structural analysis. Existing documents should be reviewed, including the plans, specifications, as-built information, field test

reports, past repair documents, and maintenance history documents. The engineer should conduct a thorough field investigation of the existing structure. The load-carrying capacity of the existing structure should be based on the information collected in the field investigation and the review of the existing documents and determined by analytical or other suitable methods. Load tests or other methods can be incorporated into the overall evaluation process if deemed appropriate (ACI 440M, 2004). The engineer should review the available literature and consult the producers Bondo-TechFab about the GGRP system to ensure that the selected system and protective coating are appropriate for the application.

It is assumed that the strengthening system will be correctly applied by workers adequately qualified. The strengthening design has to provide sufficient resistance capacity for the ultimate and service loads, and it has to guarantee the required durability taking into account the characteristics of the structure itself and the environment conditions.

In case of fire, to prevent the collapse of the strengthened structures, the GGRP contribution has to be neglected. The design philosophy of this guideline is to treat the strengthening as supplemental reinforcement. Due to the low temperature resistance of most FRP materials, the strength of externally bonded FRP systems is assumed to be completely lost in a fire. The GGRP contribution could be maintained only when adequate fire protection is given. GGRP strengthened structures should comply with all applicable building and fire codes. The structural member without the GGRP should withstand the portions of dead and service load as indicated in ACI 440.2R-02 (i.e., 1.03 Dead Load + 0.80 Live Load). Currently, there are few standards or failure criteria for structures that are repaired with FRP materials under fire loads. There exists a need to provide experimental tests and develop rational guidelines and standards (Karbhari et al., 2003).

The GGRP system has to be considered working only in tension. The parts of GGRP in compression have to be neglected.

The condition and strength of the masonry substrate should be evaluated to determine its capacity for strengthening of the member with externally bonded FRP reinforcement. Substrate strength is an important parameter for bond-critical applications, including flexure or shear strengthening. The existing masonry substrate should possess the necessary strength to develop the design stresses of the GGRP system through bond. Anchoring devices could be used but are not considered in this guide.

Masonry panels could be strengthened by means of GGRP to increase first the ultimate load capacity and second the ultimate displacements of the structural member in the case of out-of-plane and in-plane loads.

### **7.1.2 Strength design methodology**

The design of GGRP reinforcement for out-of-plane and in-plane loads is based on limit state principles. The design process for masonry walls requires investigating several possible failure modes and limit states (CNR-DT 200, 2004).

In this guideline the strength design approach of reinforced masonry members is adopted, to assure consistency with the Building Code Requirements for Masonry Structures (ACI 530-02/ASCE 5-02/ TMS 402-02) and with other ACI document on masonry (ACI 530.1-02/ACSE 6-02/TMS 602-02 “Specification for Masonry Structures”, ACI 530-02/ASCE 5-02/TMS 402-02 “Commentary on Building Code Requirement for Masonry Structures”, ACI 530.1-02/ASCE 6-02/TMS 602-02 “Commentary on Specification for Masonry Structures”).

In this design guideline, the masonry member is designed based on its required strength and then checked for fatigue, creep rupture and serviceability. This guide will benefit from experimental analytical improvements to be envisioned as this technology becomes more popular.

The strength reduction factors given in Building Code Requirements for Masonry Structures (ACI 530-02/ASCE 5-02/ TMS 402-02) are used in this guideline, unless otherwise noted.

The load factors given in ASCE 7-98 “Minimum Design Loads for Building and Other Structures” are used, unless otherwise noted.

## **7.2 DESIGN MATERIAL PROPERTIES**

The materials considered in this guideline are the masonry and the GGRP system developed by Bondo-TechFab. The masonry material properties should be obtained from the Building Code Requirements for Masonry Structures (ACI 530-02/ASCE 5-02/ TMS 402-02) or equivalent codes or as provided by the producers. For the GGRP system, the materials properties are those provided in this guide.

### **7.2.1 GGRP Design Material Properties**

The GGRP material is considered linear elastic up to failure. The material properties guaranteed by the manufacturer (see CH 2) should be considered as initial values that do not include the effects of long-term exposure to the environment. Because long-term exposure to various type of environment can reduce the tensile strength and creep rupture and fatigue endurance of the GGRP system, the material properties used in design

equations should be reduced based on the type and level of environment and loads exposure.

Equations (7.1) to (7.2) give the tensile properties that should be used for the design, taking into account the environment exposure. The design strength,  $f_{fu}$ , should be determined, according to ACI 440.2R-02 as:

$$f_{fu} = C_E f_{fu}^* \quad (7.1)$$

where:  $C_E$  is the environment reduction factor given in *Table 7-1*,  $f_{fu}^*$  is the guaranteed tensile strength of GGRP provided by the manufactures.

**Table 7-1: Environment Reduction Factors**

Exposure condition	Fiber type	Environment reduction factor $C_E$
Masonry, interior exposition	Glass	0.75
Masonry, exterior exposition	Glass	0.65
Masonry, aggressive environment	Glass	0.50

The design rupture strain should be determined as:

$$\varepsilon_{fu} = C_E \varepsilon_{fu}^* \quad (7.2)$$

where:  $\varepsilon_{fu}^*$  is the guaranteed rupture strain of the GGRP system.

The design modulus of elasticity is assumed to be the same as the value reported by the manufacturer:  $E_f = E_{f,ave}$ .

### 7.2.1.1 Reduction for debonding at ultimate

GGRP debonding can occur if the force in the GGRP cannot be sustained by the interface of the substrate. In order to prevent debonding of the GGRP, a limitation should be placed on the strain level developed in the laminate. The debonding of GGRP in flexure or shear is accounted through a parameter  $k_m$ . The effective design strength and strain,  $f_{fe}$  and  $\varepsilon_{fe}$ , of the GGRP should be considered as:

$$f_{fe} = k_m f_{fu} = k_m C_E f_{fu}^* \quad (7.3)$$

$$\varepsilon_{fe} = k_m \varepsilon_{fu} = k_m C_E \varepsilon_{fu}^* \quad (7.4)$$

Based on test results on un-reinforced masonry (URM) walls strengthened with FRP laminates (Tumialan et al., 2003), it is reasonable to assume  $k_m=0.65$  also for GGRP systems.

The parameter  $k_m$  should be determined experimentally and related to the specific GGRP and masonry systems. A scientific approach based on fracture mechanics is presented in Appendix III; such method allows determining the effective design strength and the development length based on the energy required to fracture the interface between masonry and GGRP.

### 7.2.1.2 Reduction for creep rupture at service

Walls subjected to sustained load such as retaining or basement walls, creep rupture considerations need to be taken into account (ACI 440.2R-02, 2002). In such cases, for serviceability check, the designed admissible tensile stress,  $f_{f,s}$ , should not exceed:

$$f_{f,s} = 0.20 f_{fu} \quad (7.5)$$

## 7.2.2 Masonry

The masonry material shows a nonlinear behavior in compression, and a negligible tensile strength disregarded in the present guideline. The stress distribution for the part of masonry in compression should be determined from an appropriate nonlinear stress-strain relationship or by a rectangular stress block suitable for the given level of strain in the masonry. The stress block has dimensions  $\gamma f'_m$  and  $\gamma d$ . Expressions for  $\beta_1$  and  $\gamma$  are given in equations (7.6) through (7.14).

a) Case when masonry crushing does not control

$$\beta_1 = 2 - \frac{4 \left[ \left( \frac{\varepsilon_m}{\varepsilon'_m} \right) - \tan^{-1} \left( \frac{\varepsilon_m}{\varepsilon'_m} \right) \right]}{\left( \frac{\varepsilon_m}{\varepsilon'_m} \right) \ln \left( 1 + \left( \frac{\varepsilon_m}{\varepsilon'_m} \right)^2 \right)} \quad (7.6)$$

$$\gamma = 0.90 \frac{\ln \left( 1 + \left( \frac{\epsilon_m}{\epsilon'_m} \right)^2 \right)}{\beta_1 \left( \frac{\epsilon_m}{\epsilon'_m} \right)} \quad (7.7)$$

where:

$$\epsilon'_m = \frac{1.71 f'_m}{E_m} \quad (7.8)$$

and  $\tan^{-1} \left( \frac{\epsilon_m}{\epsilon'_m} \right)$  is computed in radians. The strength and the modulus of elasticity of the masonry can be computed as recommended in the Building Code Requirements for Masonry Structures (ACI 530-02/ASCE 5-02/ TMS 402-02):

$$E_m = 700 f'_m \text{ , for clay masonry} \quad (7.9)$$

$$E_m = 900 f'_m \text{ , for concrete masonry} \quad (7.10)$$

and assuming for  $\epsilon'_m$  the following values:

$$\epsilon'_m = 0.0024 \text{ , for clay masonry} \quad (7.11)$$

$$\epsilon'_m = 0.0019 \text{ , for concrete masonry} \quad (7.12)$$

b) Case when masonry crushing controls

The maximum usable strain,  $\epsilon_{mu}$ , at the extreme compressive fiber is assumed:

$$\epsilon_{mu} = 0.0035 \text{ , for clay masonry} \quad (7.13)$$

$$\epsilon_{mu} = 0.0025 \text{ , for concrete masonry} \quad (7.14)$$

When masonry crushing failure occurs the parameters  $\beta_1$  and  $\gamma$  can assume the values shown in Table 7-2.

**Table 7-2: Stress Block Patameters  $\beta_1$  and  $\gamma$**

Parameter	Concrete	Clay
$\beta_1$	0.805	0.822
$\gamma$	0.853	0.855

## 7.3 STRENGTH REDUCTION FACTORS

### 7.3.1 Design strength

Masonry members shall be proportioned such that the design strength equals or exceeds the required strength. Design strength is the nominal strength,  $S_n$ , multiplied by the strength reduction factor,  $\phi$ , with values as specified in section 7.3.2. The demand refers to the load effects,  $U_u$ , calculated from factored loads (for example,  $1.2D + 1.6L + \dots$ ), therefore:

$$\phi S_n \geq U_u \quad (7.15)$$

The design shear strength,  $\phi V_n$ , shall exceed the shear corresponding to the development of 1.25 times the nominal flexural strength,  $M_n$ , of the member, except that the nominal shear strength,  $V_n$ , need not exceed 2.5 times the required shear strength,  $V_u$ .

In the case of in-plane loads, the shear contribution of the GGRP system,  $V_{m,f}$ , is suggested not exceed  $0.5V_m$ , where  $V_m$  is the shear contribution of masonry, and cannot be larger than  $V_m$ .

### 7.3.2 Strength reduction factors

- **For axial load in strengthened masonry:** the value of  $\phi$  shall be taken as 0.70 for masonry strengthened with GGRP subjected to axial load.
- **For axial load in infill and load-bearing walls for which the arching action cannot be neglected:** for these cases, the reduction factor,  $\phi$ , shall be taken as 0.6.
- **For flexure load in strengthened masonry:** the value of  $\phi$  for masonry strengthened with GGRP subjected to flexure and/or axial loads shall be taken as 0.7.
- **For shear:** the value of  $\phi$  shall be taken as 0.80 for masonry strengthened with GGRP and subjected to shear.
- **Development length and splices:** for development length and splices of the strengthening system,  $\phi$  shall be taken as 0.80.

#### 7.4 SERVICEABILITY CONSIDERATIONS

Masonry structures strengthened with GGRP systems should be consistent with the Building Code Requirements for Masonry Structures (ACI 530-02/ASCE 5-02/ TMS 402-02).

No additional requirements are necessary for serviceability evaluation except for  $f_{fe} \leq 0.20 f_{fu}$ .

CONFIDENTIAL



## CHAPTER 8 STRENGTHENING FOR OUT-OF-PLANE LOADS

### 8.1 GENERAL CONSIDERATIONS

Masonry panels are prone to fail under out-of-plane loads. This kind of failure could be due by earth pressure, seismic loads, dynamic vibrations, verticality flaw, wind pressure, and by arc thrust (CNR DT, 2004, Tumialan, 2003-a).

The failure modes of URM walls strengthened with FRP subject to out-of-plane loads can be summarized as follow:

**FRP debonding:** due to shear transfer mechanisms at the interface masonry/FRP, debonding may occur before flexural failure. Debonding starts from flexural cracks at the maximum bending moment region and develops towards the support. Since the tensile strength of masonry is lower than that of the resin, the failure typically occurs in the masonry (Tumialan, 2003-a, Hamilton, 2001).

**Flexural failure:** after developing flexural cracks primarily located at the mortar joints, a failure can occur either by rupture of the FRP laminate or masonry crushing (Tumialan, 2003-a, Tumialan, 2003-b). Typically, flexural failure of masonry strengthened with FRPs is due to compressive crushing in walls strongly strengthened. FRP rupture is less desirable than masonry crushing being that the latter more ductile (Triantafillou, 1998). Both failure modes are acceptable in governing the design of out-of-plane loaded walls strengthened with GGRP system provided that strength and serviceability criteria are satisfied.

**Shear failure:** cracking starts with the development of fine vertical cracks at the maximum bending region. Thereafter, two types of shear failure could be observed: flexural-shear or sliding shear. The first type is oriented at approximately  $45^\circ$ , and the second type occurs along bed joint, near the support, causing sliding of the wall at that location. The crack due to flexural-shear mode cause a differential displacement in the shear plane, which often results in FRP debonding (Tumialan, 2003-a, Hamoush, 2002)

The recommendations given in this chapter are only for members of rectangular cross-sections with strengthening applied to one side, as the experimental work has almost exclusively considered members with this shape and the GGRP is considered working only in tension, not in compression.

## 8.2 STRENGTHENING WITH GGRP

### 8.2.1 General assumption and considerations

The following assumptions and limitations should be adopted:

- The strains in the reinforcement and masonry are directly proportional to the distance from the neutral axis, that is, a plane section before loading remains plane after loading.
- The maximum usable strain,  $\varepsilon_{mu}$ , at the extreme compressive side is assumed to be 0.0035 (in./in.) for clay masonry and 0.0025 (in./in.) for concrete masonry.
- The tensile strength of masonry is neglected.
- The tensile behavior of the GGRP is linear elastic until failure, and the maximum usable strain in the reinforcement is considered to be  $\varepsilon_{fe} = k_m \varepsilon_{fu}$ ; where  $k_m$  is a bond dependent coefficient.
- There is no relative slip between external GGRP reinforcement and the masonry, until debonding failure.
- The wall can be assumed to behave under simply supported conditions (i.e. arching mechanism is not present).

### 8.2.2 Flexural behavior of non-load bearing walls

The ultimate strength design criterion states that the design flexural capacity of a member must exceed the flexural demand (Eq. 8.1).

$$\phi M_n \geq M_u \quad (8.1)$$

Computations are based on force equilibrium and strain compatibility. The distribution of strain and stress in the GGRP reinforced masonry for a rectangular cross-section under out-of-plane load is shown in Figure 8-1. The value of the stress block parameters  $\gamma$  and  $\beta_1$  associated with a parabolic compressive stress distribution are given in section 7.2.2.

The GGRP design strength has to account for the effects of environmental exposure by means of the coefficient  $C_E$  as defined in section 7.2.1, and for the effects of debonding by the parameter  $k_m$  defined in section 7.2.1.1.

The general equations to evaluate the nominal moment capacity,  $M_n$ , for a strip of masonry are given as:

$$(\gamma f'_m)(\beta_1 c) b = A_f f_f \quad (8.2)$$

$$M_n = (\gamma f'_m)(\beta_1 c) b \left( t - \frac{\beta_1 c}{2} \right) \quad (8.3)$$

$$\frac{\epsilon_m}{c} = \frac{\epsilon_f}{t-c} = \frac{\epsilon_m + \epsilon_f}{t} \quad (8.4)$$

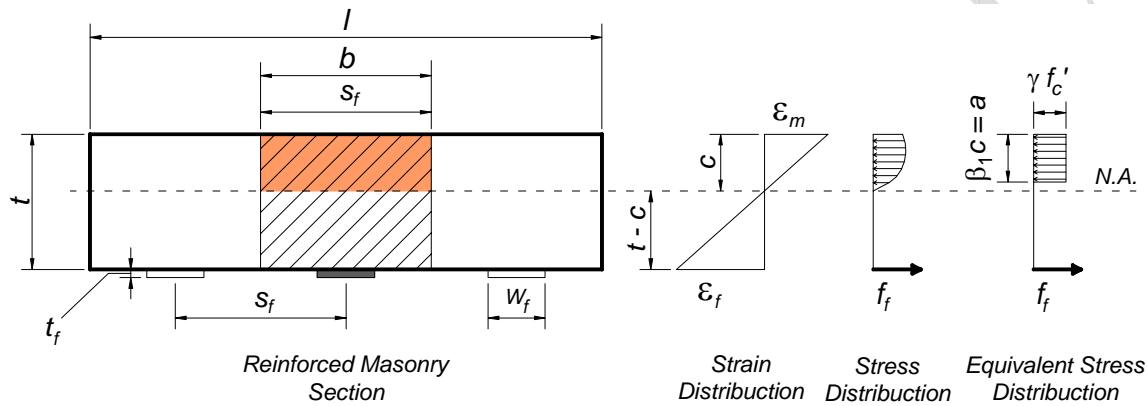

$A_f = n t_f w_f$      $n = \text{number of grids}$      $t_f = \text{thickness of one grid}$      $w_f = \text{width of the strip}$

**Figure 8-1: Internal strain and stress distribution for a horizontal rectangular section of a strip of masonry under out-of-plane loads, without axial compression**

### 8.2.2.1 Failure mode

The flexural capacity of GGRP strengthened masonry subject to out-of-plane loads is dependent on whether the failure is governed by masonry crushing or GGRP debonding or rupture. The failure mode can be determined by comparing the GGRP reinforcement ratio for a strip of masonry to the balanced reinforcement ratio, defined as the ratio where masonry crushing and GGRP debonding or rupture occur simultaneously. The GGRP reinforcement ratio for a strip of masonry is computed as:

$$\rho_f = \frac{A_f}{b t} \quad (8.5)$$

then, according to equilibrium and compatibility, the balanced reinforcement ratio is:

$$\rho_{fb} = \gamma \beta_1 \frac{f'_m \varepsilon_{mu}}{f_{fe} \varepsilon_{mu} + \varepsilon_{fe}} = \gamma \beta_1 \frac{f'_m E_f \varepsilon_{mu}}{f_{fe} E_f \varepsilon_{mu} + f_{fe}} \quad (8.6)$$

If the reinforcement ratio is below the balanced ratio ( $\rho_f < \rho_{fb}$ ), GGRP rupture or debonding failure mode governs. Otherwise, when  $\rho_f > \rho_{fb}$ , masonry crushing governs.

### 8.2.2.2 Nominal flexural capacity

Masonry crushing failure:

When  $\rho_f > \rho_{fb}$ , the failure is initiated by crushing of the masonry, and the stress distribution in the masonry given in section 7.2.2 can be approximated with a rectangular stress block defined by the parameters  $\beta_1$  and  $\gamma$  that in this case assume the values shown in Table 7.2.

According to 440.1R-03 and based on the equations (8.2) to (8.4) the following equations can be derived:

$$M_n = (\gamma f'_m) a b \left( t - \frac{a}{2} \right) = A_f f_f \left( t - \frac{a}{2} \right) \quad (8.7)$$

$$a = \beta_1 c = \frac{A_f f_f}{\gamma f'_m b} \quad (8.8)$$

$$f_f = E_f \varepsilon_{mu} \frac{\beta_1 t - a}{a} \quad (8.9)$$

Substituting  $a$  from Eq. (8.8) into Eq. (8.9) and solving for  $f_f$  gives:

$$f_f = \left( \sqrt{\left( \frac{E_f \varepsilon_{mu}}{2} \right)^2 + \frac{\gamma \beta_1 f'_m E_f \varepsilon_{mu}}{\rho_f} - \frac{E_f \varepsilon_{mu}}{2}} \right) \leq f_{fe} \quad (8.10)$$

The nominal flexural strength can be determined from Eq. (8.7), (8.8) and (8.9). Based on compatibility, the stress level in the GGRP can be found from Eq. (8.10), and needs to be less or equal to  $f_{fe}$ .

The nominal flexural capacity can be also expressed in terms of the GFRP Grid reinforcement ratio as:

$$M_n = \rho_f f_f \left( 1 - \frac{f_f \rho_f}{2\gamma f_m'} \right) b t^2 \quad (8.11)$$

Alternatively, the depth of the neutral axis can be express as:

$$c = \frac{a}{\beta_1} = \frac{\rho_f t}{\beta_1 \gamma f_m'} \left[ \sqrt{\left( \frac{E_f \varepsilon_{mu}}{2} \right)^2 + \frac{\beta_1 \gamma f_m'}{\rho_f} E_f \varepsilon_{mu}} - \frac{E_f \varepsilon_{mu}}{2} \right] \quad (8.12)$$

### GGRP debonding or rupture:

When  $\rho_f < \rho_{fb}$ , the failure of the wall is initiated by rupture or debonding of the GGRP, and the equivalent stress block depends on the maximum strain reached by the masonry. In this case, an iterative process should be used to determine the equivalent stress block. The analysis incorporates four unknowns: the masonry compressive strain at the failure  $\varepsilon_m$ , the depth to the neutral axis  $c$ , and the parameters  $\beta_1$  and  $\gamma$ .

Once the value of the four parameters have been found, the flexural capacity can be computed as shown in Eq. (8.13):

$$M_n = A_f f_{fe} \left( t - \frac{\beta_1 c}{2} \right) \quad (8.13)$$

For this type of failure, the upper limit of the product  $\beta_1 c$  for balanced conditions (as defined in section 7.2.2), and it is equal to  $\beta_1 c_b$ . Therefore, a simplified and conservative calculation of the nominal flexural capacity of the member can be based on Eq. (8.14) and (8.15):

$$M_n = A_f f_{fe} \left( t - \frac{\beta_1 c_b}{2} \right) \quad (8.14)$$

$$c_b = \left( \frac{\varepsilon_{mu}}{\varepsilon_{mu} + \varepsilon_{fe}} \right) t \quad (8.15)$$

### 8.2.3 Flexural behavior of load bearing walls

The ultimate strength design criterion states the design capacity of a member subject to flexural and axial load should be:

$$\frac{P_u}{\phi P_n} + \frac{M_u}{\phi M_n} \leq 1 \quad (8.16)$$

Computations are based on force equilibrium and strain compatibility. The geometry of the un-cracked cross-section is given in Figure 8-2. The distribution of strain and stress in the GGRP reinforced masonry for a rectangular section under out-of-plane and axial loads are shown in Figure 8-3. The stress block parameters  $\gamma$  and  $\beta_1$  associated with a parabolic compressive stress distribution are given in section 7.2.2.

The GGRP design strength has to account for the effects of environmental exposure by means of the coefficient  $C_E$  as defined in section 7.2.1, and for the effects of debonding by the parameter  $k_m$  defined in section 7.2.1.1.

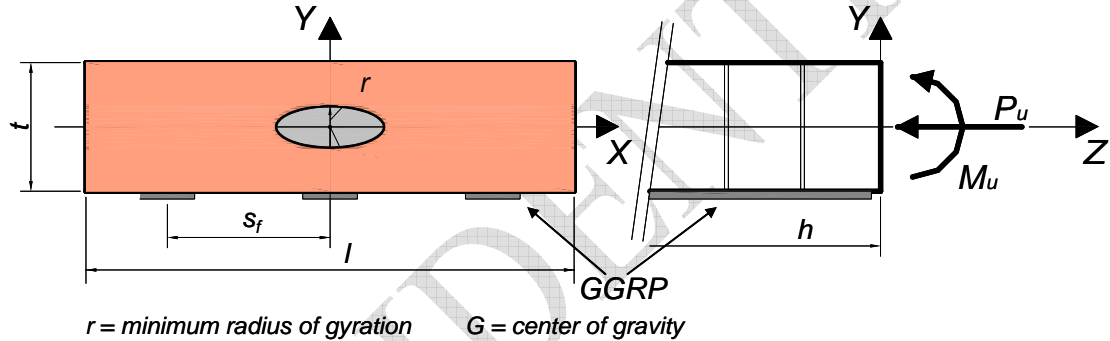

**Figure 8-2: Geometric parameters of the uncracked section under out-of-plane loads with axial compression**

The nominal axial strength,  $P_n$ , for the masonry strip of width  $b$  (Fig. 8-3) should be evaluated according to the Building Code Requirements for Masonry Structures (ACI 530-02/ASCE 5-02/TMS 402-02), and shall not exceed the values given in Eq. (8.17) or Eq. (8.18).

(a) For members having  $\frac{h}{r} \leq 99$ :

$$P_n = 0.80 \left[ 0.80 f'_m A_n \right] \left[ 1 - \left( \frac{h}{140r} \right)^2 \right] \quad (8.17)$$

(a) For members having  $\frac{h}{r} > 99$ :

$$P_n = 0.80 \left[ 0.80 f'_m A_n \right] \left( \frac{h}{70r} \right)^2 \quad (8.18)$$

where, in this paragraph,  $r$  is the minimum radius of gyration of the uncracked cross-section of width  $l$  (Figure 8-2),  $A_n$  is the net cross-section area of the masonry strip of width  $b$  (Figure 8-3), and  $h$  the effective height of wall.

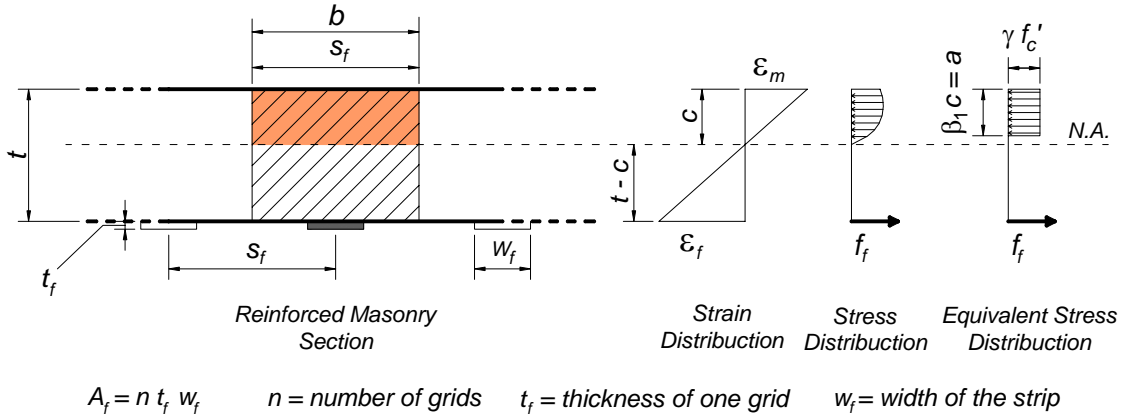

**Figure 8-3: Internal strain and stress distribution for a horizontal rectangular section of a strip of masonry under out-of-plane loads, with axial compression**

Using the stress distribution for a masonry section subject to flexural and axial load, the general equations of equilibrium and compatibility, written relative to the center of gravity, G, are given as:

$$(\gamma f'_m)(\beta_1 c)b - P_u = A_f f_f \quad (8.19)$$

$$M_n = (\gamma f'_m)(\beta_1 c)b \left( t - \frac{\beta_1 c}{2} \right) + A_f f_f \frac{t}{2} \quad (8.20)$$

$$\frac{\epsilon_m}{c} = \frac{\epsilon_f}{t - c} = \frac{\epsilon_m + \epsilon_f}{t} \quad (8.21)$$

The moment  $M_n$  can be also evaluated relative to the GGRP reinforcement (Eq. 8.22) or to the center of compression of the masonry (Eq. 8.23).

$$M_n = (\gamma f'_m)(\beta_1 c)b \left( t - \frac{\beta_1 c}{2} \right) - P_u \frac{t}{2} \quad (8.22)$$

$$M_n = A_f f_f \left( t - \frac{\beta_1 c}{2} \right) + P_u \left( \frac{t}{2} - \frac{\beta_1 c}{2} \right) \quad (8.23)$$

### 8.2.3.1 Failure mode

The flexural capacity of a GGRP load bearing wall is dependent on failure mode. The failure mode can be determined by comparing the GGRP reinforcement ratio (Eq. 8.5) to the balanced reinforcement ratio Eq (8.24).

$$\rho_{fb} = \frac{f'_m}{f_{fe}} \left[ \gamma \beta_1 \frac{\epsilon_{mu}}{\epsilon_{mu} + \epsilon_{fe}} - \frac{P_u}{b t f'_m} \right] = \frac{f'_m}{f_{fe}} \left[ \gamma \beta_1 \frac{E_f \epsilon_{mu}}{E_f \epsilon_{mu} + f_{fe}} - \frac{P_u}{b t f'_m} \right] \quad (8.24)$$

If the reinforcement ratio is below the balanced ratio ( $\rho_f < \rho_{fb}$ ), GGRP rupture or debonding failure mode governs. Otherwise, ( $\rho_f > \rho_{fb}$ ) masonry crushing governs.

### 8.2.3.2 Nominal flexural capacity

Masonry crushing failure:

When  $\rho_f > \rho_{fb}$ , the failure is initiated by crushing of the masonry, and the stress distribution in the masonry given in section 7.2.2 can be approximated with a rectangular stress block defined by the parameters  $\beta_1$  and  $\gamma$  that in this case assume the values shown in Table 7-2. Based on equations (8.19) to (8.23), the following expressions can be derived:

$$M_n = (\gamma f'_m) a b \left( t - \frac{a}{2} \right) - P_u \frac{t}{2} = A_f f_f \left( t - \frac{a}{2} \right) + P_u \left( \frac{t}{2} - \frac{a}{2} \right) \quad (8.25)$$

$$a = \beta_1 c = \frac{(A_f f_f + P_u)}{\gamma f'_m b} \quad (8.26)$$

$$f_f = E_f \epsilon_{mu} \frac{\beta_1 t - a}{a} \quad (8.27)$$



Considering equations from (8.25) to (8.27), in the case of masonry crushing, the following values for  $f_f$  and  $c$  can be obtained:

$$f_f = \left( \sqrt{\left( \frac{E_f \varepsilon_{mu}}{2} - \frac{P_u}{2A_f} \right)^2 + \left( \frac{\gamma \beta_1 f_m'}{\rho_f} - \frac{P_u}{A_f} \right) E_f \varepsilon_{mu}} - \left( \frac{E_f \varepsilon_{mu}}{2} + \frac{P_u}{2A_f} \right) \right) \leq f_{fe} \quad (8.28)$$

$$c = \frac{a}{\beta_1} = \frac{\rho_f t}{\beta_1 \gamma f_m'} \left[ \sqrt{\left( \frac{E_f \varepsilon_{mu}}{2} - \frac{P_u}{2A_f} \right)^2 + \frac{\beta_1 \gamma f_m'}{\rho_f} E_f \varepsilon_{mu}} - \left( \frac{E_f \varepsilon_{mu}}{2} - \frac{P_u}{2A_f} \right) \right] \quad (8.29)$$

#### GGRP debonding or rupture:

When  $\rho_f < \rho_{fb}$ , the failure of the wall is initiated by debonding or rupture of the GGRP, and the equivalent stress block depends on the maximum strain reached by the masonry. In this case, an iterative process should be used to determine the equivalent stress block. The analysis incorporates four unknowns given the value of  $P_u$ : the masonry compressive strain at failure  $\varepsilon_m$ , the depth to the neutral axis  $c$ , and the parameters  $\gamma$  and  $\beta_1$ . Solving for this system of equations may be laborious.

Alternatively, according to the Building Code Requirements for Masonry Structures (ACI 530-02/ASCE 5-02/TMS 402-02, section 3.2.2) values of  $\beta_1$  and  $\gamma$  equal to 0.80 can be assumed. Therefore, the following simplified equations can be used:

$$M_n = (0.80 f_m') (0.80 c) b \left( t - \frac{0.80 c}{2} \right) - P_u \frac{t}{2} \quad (8.30)$$

$$c = \frac{\rho_f t}{0.80^2 f_m'} \left[ \sqrt{\left( \frac{E_f \varepsilon_{mu}}{2} - \frac{P_u}{2A_f} \right)^2 + \frac{0.80^2 f_m'}{\rho_f} E_f \varepsilon_{mu}} - \left( \frac{E_f \varepsilon_{mu}}{2} - \frac{P_u}{2A_f} \right) \right] \quad (8.31)$$

$$f_f = E_f \varepsilon_{mu} \frac{t-c}{c} \leq f_{fe} \quad (8.32)$$

#### **8.2.4 Shear behavior for flexural behavior**

The nominal moment calculated for flexural behavior should be compared and, if necessary, limited by the one associated with shear failure. In fact, if a large amount of GGRP is applied, the failure can be controlled by shear instead of flexure. The theoretical shear capacity of the GGRP strengthened masonry should be evaluated according to the

Building Code Requirements for Masonry Structures (ACI 530-02/ASCE 5-02/TMS 402-02).

The shear strength capacity should exceed the shear demand, as shown in (8.33):

$$\phi V_n \geq V_u \quad (8.33)$$

Due to the fact that the GGRP system is only bonded onto the masonry surface, its contribution can be neglected, and the nominal strength becomes:

$$V_n = V_m \quad (8.34)$$

The shear strength provided by the masonry,  $V_m$ , shall be computed using equation (8.35) for non-load bearing walls, and equation (8.36) for load bearing walls. The value of  $\frac{M}{Vt}$  need not be taken greater than 1.0.

$$V_m = \left[ 4.0 - 1.75 \left( \frac{M}{Vt} \right) \right] A_n \sqrt{f'_m} \quad (8.35)$$

$$V_m = \left[ 4.0 - 1.75 \left( \frac{M}{Vt} \right) \right] A_n \sqrt{f'_m} + \frac{P}{4} \quad (8.36)$$

Where  $M$  is the maximum moment at the section under consideration,  $V$  is the corresponding shear force,  $t$  the thickness of the masonry,  $A_n$  the net cross-section area of the masonry strip of width  $b$ ,  $f'_m$  the specified compressive strength of masonry and  $P$  is the axial load.

The nominal shear capacity,  $V_n$ , shall not exceed the following limits:

(a) When  $\frac{M}{Vt} \leq 0.25$ :

$$V_n \leq 6A_n \sqrt{f'_m} \quad (8.37)$$

(b) When  $\frac{M}{Vt} \geq 1.00$

$$V_n \leq 4A_n \sqrt{f'_m} \quad (8.38)$$

(c) For values of  $\frac{M}{Vt}$  falling in the range 0.25 to 1.00, a linear interpolation can be used to determine the limiting value of  $V_n$ , as shown below in Figure 8-4.

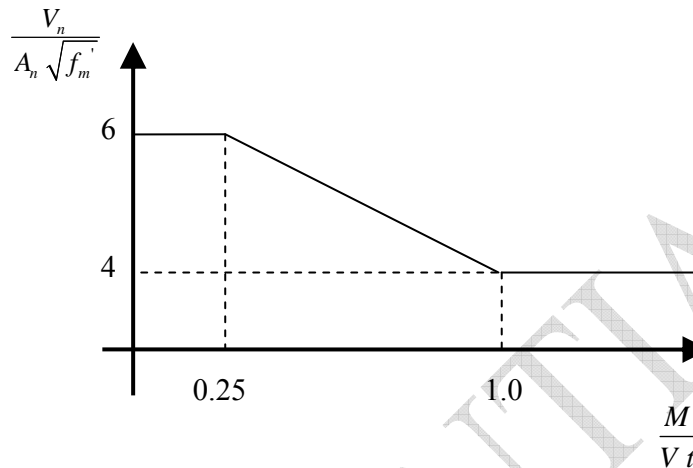

**Figure 8-4: Linear interpolation for determining the value of  $V_n$  when:**

$$0.25 < \frac{M}{Vt} < 1.0$$

### 8.3 STRENGTHENING LIMITATIONS DUE TO ARCHING ACTION

For walls with low slenderness ratio built between rigid supports, when the out-of-plane deflection increases, the wall is restrained from rotation at its ends. This action induces an in-plane compressive force, which, depending on the degree of support fixity, can significantly increase the wall capacity. This mechanism is known as arching effect.

Due to arching, the increase of capacity in walls strengthened with FRP laminates may be considerably less than expected because the wall is in reality very strong to begin with. The load-resisting mechanism for FRP-strengthened URM walls depends on the tensile strength of masonry, in-plane compressive strength, boundary conditions, wall slenderness ratio (height/thickness), and material and bond properties of the FRP.

When a wall is built between supports that restrain the outward movement, membrane compressive forces in the plane of the wall, accompanied by shear forces at the supports, are induced as the wall bends. The in-plane compression forces can delay cracking. After cracking, a so-called arching action can be observed. Due to this action, the capacity of the wall can be much larger than that computed assuming simply supported conditions. Experimental works (Tumialan et al., 2003, Galati, 2002, Carney, 2003), have shown that

the resultant force between the out-of-plane load and the induced membrane force could cause the crushing of the masonry units at the boundary regions.

The arching mechanism must be considered in the quantification of the upgraded wall capacity to avoid overestimating the contribution of the strengthening. Three different modes of failure have been observed in walls exhibiting the arching mechanism:

- flexural failure (i.e. rupture of the FRP laminate in tension or crushing of the masonry in compression)
- crushing of masonry at the boundary regions
- shear failure

Figure 8-5 illustrates a comparison between the load-deflection curves obtained in the case of simply supported walls and walls with the end restraints, tested under four point bending (Galati et al., 2002). A significant influence of the boundary conditions in the wall behavior is observed. If the wall behaves as a simply supported element (i.e. large slenderness ratio or ends not restrained), the FRP reinforcement is very effective since the wall is in pure flexure and the cracks are bridged by the reinforcement. In the case of the control simply supported specimen, the unstrengthened URM wall collapsed when the vertical load was only about 0.7 kips.

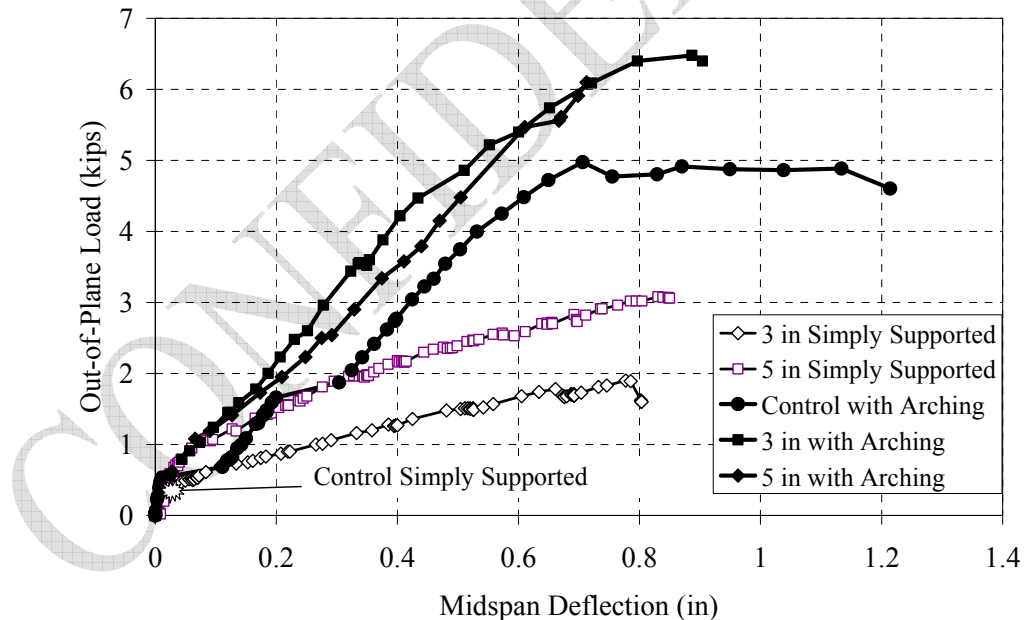

**Figure 8-5: Comparison between Simply Supported and End-Restrained Walls**

Figure 8-5 shows that the increase in the ultimate load for walls strengthened with 3 in. and 5 in. wide GFRP laminates were about 175 and 325%, respectively. If the wall is restrained (i.e. arching mechanism is observed) the same effectiveness of the FRP reinforcement is not observed because crushing of the masonry units at the boundary

regions controls the wall behavior. In this case, the increase in the out-of-plane capacity for strengthened specimens with 3 and 5 in. wide GFRP laminates was about 25%. It is to be stressed that capacity of an unstrengthened URM wall with end restrains is far superior to that of an identical simply supported wall with FRP strengthening.

### 8.3.1 Design Procedure

When a non load bearing wall is built solidly between supports capable of resisting an arch thrust with no appreciable deformation or when walls are built continuously past vertical supports (horizontal spanning walls), the lateral load resistance of the wall can benefit from the arching action if height to thickness ratio is less than 20. In such cases, the ultimate strength design criteria states the design ultimate load capacity of a member should be:

$$\phi q_n \geq q_u \quad (8.39)$$

where  $\phi = 0.6$  as defined in section 7.3.2, and  $q_n$  and  $q_u$  have dimensions  $\frac{lb}{in}$ . The design procedure for unstrengthened and strengthened walls is presented herein.

The design procedure presented herein allows determining the nominal resisting uniform force,  $q_n$ , for both unstrengthened and strengthened URM walls. The resisting force for loading conditions other than the uniform pressure can be derived from  $q_n$ .

The resisting force,  $Q_n$ , for a concentrated load at mid-height of the wall is given by equation (8.40):

$$Q_n = \frac{q_n h}{2} \quad (8.40)$$

where h is the height of the wall.

For a triangular distribution, the maximum resisting pressure  $\bar{q}_n$  can be determined using the following equation:

$$\bar{q}_n = \frac{q_n}{2} \quad (8.41)$$

### 8.3.1.1 Unstrengthened Masonry Walls

Analysis may be based on a three-pin arch, when the bearing of the arch thrust at the supports and at the central hinge should be assumed as 0.1 times the thickness of the wall, as indicated on Figure 8-6. If chases or recess occur near the thrust-lines of the arch, their effect on the strength of the masonry should be taken into account (Eurocode 6 Sec. 6.3.2).

The arch thrust should be assessed from knowledge of the applied lateral load, the strength of the masonry in compression, the effectiveness of the junction between the wall and the support resisting the thrust, and the elastic and time depending shortening of the wall. The arch thrust may be provided by a vertical load (Eurocode 6 Sec. 6.3.2).

The resisting force,  $q_n$ , per width  $b$  of wall is given by equation 8.42:

$$q_n = 0.58 f'_m b \left( \frac{t}{h} \right)^2 \quad (8.42)$$

Where  $b$ ,  $t$  and  $h$  are the width, thickness and height of the wall, respectively.

If the clamping force per width  $b$  of the wall,  $C$ , is needed, it can be easily computed using equation 8.43:

$$C = 0.58 f'_m \frac{bt}{10} \quad (8.43)$$

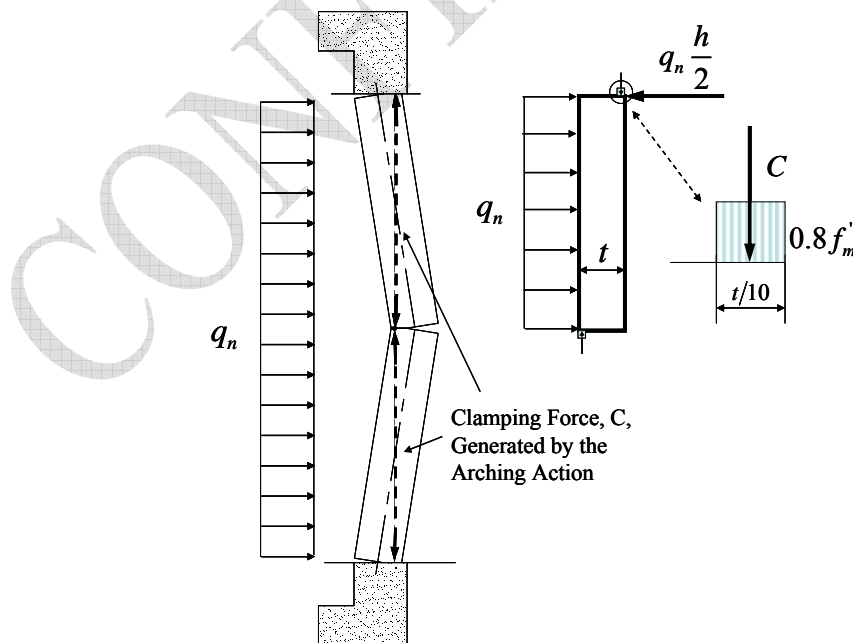

Figure 8-6: Design of Rigid Arching Walls

### 8.3.1.2 Strengthened Masonry Walls

In addition to the general assumptions presented in Section 8.2.1 the wall is also assumed cracked at mid-height, and that the two resulting segments can rotate as rigid bodies about the supports.

With reference to Figure 8.7, the resisting force per unit area of wall is given by equation 8.44:

$$q_n = \frac{8}{h^2} (\gamma_1 \beta_{11} w_m b_1 f'_m a_c + A_f f_f a_f) \quad (8.44)$$

where  $h$  is the height of the wall,  $A_f$  is the area of GGRP reinforcement,  $w_m$  is the width of the wall,  $\gamma$  and  $\beta_1$  define the stress block. The additional subscripts 1 or 2 for  $\gamma$  and  $\beta_1$  has been used to single out the corresponding section. Finally,  $a_f$  and  $a_c$  define the arm of both the force in the GGRP and of the clamping force, respectively. For small values of rotation of the wall  $\theta$ ,  $a_f$  and  $a_c$  can be determined as follows:

$$a_f = t - \frac{\beta_{12} (\varepsilon_{m2}) b_2}{2} \quad (8.45)$$

$$a_c = a_f - \frac{\beta_{11} (\varepsilon_{m1}) b_1}{2} \quad (8.46)$$

where  $b_1$  and  $b_2$  represent the bearing widths at the supports and at mid-height, respectively. It is important to notice that  $\gamma$  and  $\beta_1$  are functions of the maximum compressive strain at the considered cross-section ( $\varepsilon_{m1}$  or  $\varepsilon_{m2}$ ), as expressed in equations 7.5 and 7.6 in Chapter 7.

Equation 8.42, when accounting for equations 8.43 and 8.44, contains five unknowns:  $\varepsilon_{m1}$ ,  $\varepsilon_{m2}$ ,  $b_1$ ,  $b_2$ , and  $f_f$ . Such unknowns can be determined using the procedure based on compatibility and equilibrium equations presented herein (Galati, 2002; Tumialan et al., 2003).

The free-body diagram shown in Figure 8.7 (b) can be derived analyzing the top segment of the masonry wall depicted in Figure 8.7 (a). From the equilibrium of forces in the vertical direction, the following relationship can be drawn:

$$C_2 = C_1 + T_f \quad (8.47)$$

where  $C_1$  and  $C_2$  are the clamping forces at top and mid-height of the wall, respectively,  $T_f$  is the force in the GGRP laminate.

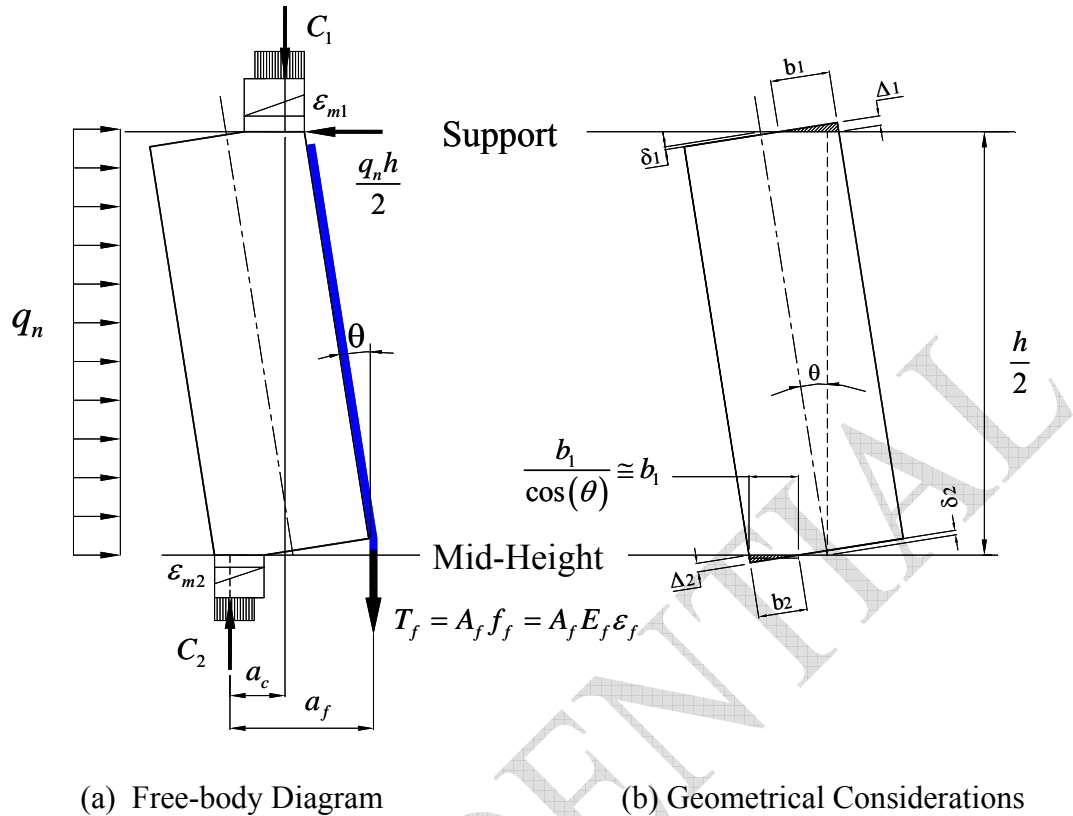

**Figure 8-7: Half Part of Analyzed Wall**

Considering the stress block distribution, the clamping forces by wall strip width,  $w_m$ , acting on the restrained ends of the wall can be calculated as:

$$C_1 = \gamma_1 \beta_{11} w_m b_1 f'_m \quad (8.48a)$$

$$C_2 = \gamma_2 \beta_{12} w_m b_2 f'_m \quad (8.48b)$$

where the additional subscripts 1 and 2 for  $\gamma$  and  $\beta_i$  have been used to single out the corresponding cross-section.

The tensile force developed by the FRP laminate is:

$$T_f = A_f f_f = A_f E_f \varepsilon_f \quad (8.48c)$$

Based on equations 8.48a, 8.48b and 8.48c, equation 8.47 can be re-written as:

$$\gamma_2 \beta_{12} w_m b_2 f'_m = \gamma_1 \beta_{11} w_m b_1 f'_m + A_f E_f \varepsilon_f \quad (8.49)$$



Equation 8.49 expresses the equilibrium of the forces. The compatibility of deformations is expressed with the following two equations (Tumialan et al., 2003)

$$t - b_1 - b_2 = \frac{h}{2} \cdot \frac{1 - \cos \theta}{\sin \theta} \cong \frac{1}{16} \frac{h^2}{b_1} \varepsilon_{m1} \quad (8.50)$$

$$\frac{b_2}{b_1} = \frac{\varepsilon_{m2}}{\varepsilon_{m1}} \quad (8.51)$$

Moreover, assuming that the deformation of the GGRP occurs in an unbonded length,  $l_b$ , the strain in the GGRP can be estimated using the equation:

$$\varepsilon_f = \frac{\frac{t - b_2}{b_2} h \varepsilon_{m1}}{16 l_b} = \frac{\frac{t - b_2}{b_1} h \varepsilon_{m2}}{16 l_b} \quad (8.52)$$

To date, there is no scientific evidence on the determination of  $l_b$ . Based on experimental observations (Tumialan et al., 2003) a suggested value for  $l_b$  is equal to 1.5 in (37.5 mm).

Given the failure mode (i.e. set the maximum value for  $\varepsilon_{m1}$  or  $\varepsilon_{m2}$  or  $\varepsilon_f$ ), equations 8.49 to 8.52 can be iteratively solved for the remaining four unknowns out of the five ( $\varepsilon_{m1}$ ,  $\varepsilon_{m2}$ ,  $b_1$ ,  $b_2$ , and  $f_f$ ). Comparing the results of the first iteration with the ultimate values of  $\varepsilon_{m1}$ ,  $\varepsilon_{m2}$  and  $\varepsilon_f$ , the actual failure mode of the wall can be determined and, therefore, the second iteration will give the actual value of all the unknowns.

If the mid-height deflection  $\Delta_o$  or the rotation  $\theta$  at failure are needed, they can be easily computed as shown:

$$\Delta_b = \left( \frac{h}{2} - \Delta_1 \right) \sin \theta = \left( \frac{h}{2} - \Delta_1 \right) \frac{\Delta_1}{\sqrt{\Delta_1^2 + b_1^2}} \quad (8.53a)$$

$$\theta = \sin^{-1} \left( \frac{\Delta_1}{\sqrt{\Delta_1^2 + b_1^2}} \right) \quad (8.53b)$$

as  $\Delta_1$  and  $\Delta_2$  are given by (Galati, 2002):

$$\Delta_1 = \frac{1}{4} \varepsilon_{m1} h \quad (8.53c)$$

$$\Delta_2 = \frac{1}{4} \varepsilon_{m2} h \quad (8.53d)$$

### 8.3.2 Shear capacity for arching action

The design shear strength for walls for which the arching action cannot be neglected, shall be in accordance with Section 8.2.4.

The shear strength provided by the masonry,  $V_m$ , shall be computed using Eq. (8.52).

$$V_m = 2A_n \sqrt{f'_m} \quad (8.54)$$

$V_n$  shall not exceed the limitations given in #8.2.4.

CONFIDENTIAL

8.4 COMPUTATION PROCEDURE

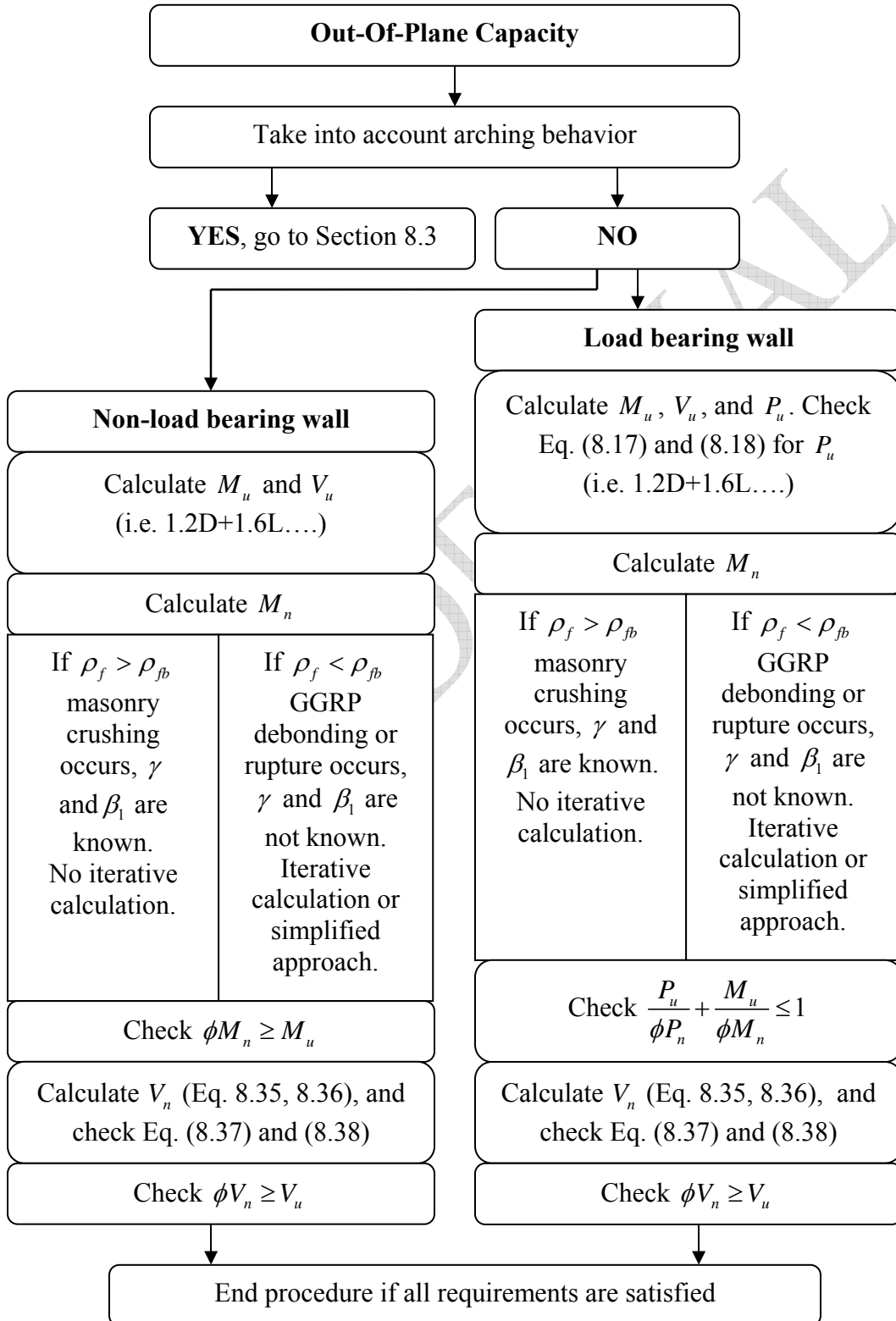

## CHAPTER 9 STRENGTHENING FOR IN-PLANE LOADS

### 9.1 GENERAL CONSIDERATIONS

#### 9.1.1 Non-load bearing walls

Masonry infill walls in frame structures have been long known to affect the strength and stiffness of the in-filled frame structures. In seismic areas, ignoring the frame-wall interaction is not always on the safe side since under lateral loads the infill walls dramatically increase the stiffness, resulting in possible change in the seismic demand due to the significant reduction in the natural period of the composite structural system. Also, the composite action of the frame-wall system changes magnitude and distribution of straining actions in the frame members, i.e. actions in critical sections in the in-filled frame differ from those in the bare frame, which may lead to unconservative or poorly detailed designs. Moreover these designs may be uneconomical since an important source of structural strength, particularly beneficial in regions of low and sometimes moderate seismic demand, is wasted. However, URM infill walls exhibit poor seismic performance under moderate and high seismic demand. This behavior is due to the rapid degradation of stiffness, strength and energy dissipation capacity, which results from the brittle sudden damage of the masonry wall (ACI 440, 2004).

The problem of considering infill walls in the design process is partly attributed to incomplete knowledge of the behavior of quasi-brittle materials such as URM and lack of conclusive experimental and analytical results to substantiate a reliable design procedure for these type of structures. The main doubts are associated with aging material properties, different failure modes along with the interaction between the in-plane and out-of-plane behavior, as well as the complicated anisotropic nature of the infill wall due to shear-compression interaction along the weak mortar joint planes. The effect of reverse cyclic in-plane forces, the incomplete knowledge of the behavior of quasi-brittle materials such as masonry and the lack of conclusive experimental and analytical results to substantiate a reliable design procedure for this type of structures, complicate rational analysis. It is not surprising that no consensus has emerged leading to a unified approach for the design of in-filled frame systems (ACI 440, 2004).

Because of the absence of consensus on engineering models for infill walls, and the different failure modes involved, the effect of masonry infill walls is often neglected in the design process for building structures. Such an assumption may lead to erroneous prediction of the lateral stiffness, strength, and ductility of the structure as well as the interaction between seismic demand and capacity. It may also lead to uneconomical design of the frames since the strength and stiffness demand on the frame could be reduced by the presence of the infill walls. (ACI 440, 2004).

If the infill wall is to be considered in the analysis and design stages, a modeling problem arises because of the many possible failure modes that need to be evaluated with a high degree of uncertainty. It is generally accepted that under lateral loads the infill wall acts as a diagonal strut connecting the two loaded corners. However, this is only applicable in the case of infill walls failing in corner crushing mode only (ACI 440, 2004).

Following principles of capacity design, undesirable modes of failure in the surrounding frame or in the masonry walls can be avoided while plastic deformations are deliberately induced in special parts of the structure. Based on the experimental and analytic knowledge, different in-plane failure modes of masonry-infill walls can be categorized into three distinct modes, namely (ACI 440, 2004):

**Sliding shear mode:** represents horizontal sliding shear failure through bed joints of a masonry infill (Figure 9-1 (a)). This failure mode is associated with infill built with weak mortar joints and frame with strong members and joints. The occurrence of this failure mode causes what is known as the knee brace effect on the frame.

**Diagonal cracking mode:** in the form of a crack connecting the two loaded corners (Figure 9-1 (b)). This failure mode is associated with frames with weak joints and strong members, and infill with strong blocks and mortar joints.

**Corner crushing mode:** represents crushing of the infill in at least one of its loaded corners (Figure 9-1 (c)). This failure mode is usually associated with infill having weak masonry blocks surrounded by a frame with weak joints and strong members.

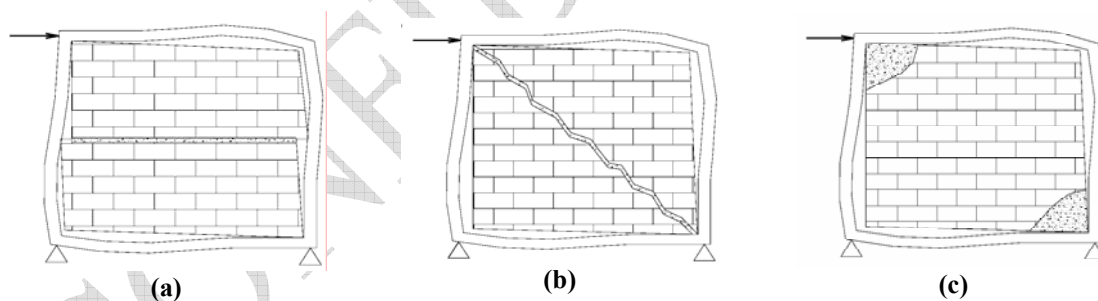

**Figure 9-1: Different Failure Modes for Masonry Infilled Frames: a) Sliding Shear Mode; b) Diagonal Cracking Mode; c) Corner Crushing Mode (ACI 440, 2004)**

### 9.1.2 Load bearing walls

The most relevant in-plane loads for a structure built with masonry walls are the seismic actions. In the case of an earthquake the structure will be subject to a series of cyclic horizontal forces, which will often cause high additional bending and shear stresses in structural walls, exceeding the elastic range of the behavior of masonry materials.

Structural walls, which are the basic resisting element to seismic loads, may be damaged, and if they have not been properly designed and detailed to withstand inelastic deformation and to dissipate energy, the induced inertia forces might cause heavy damage or even collapse of the building (Tomažević, 2000).

According to the results of earthquake damage analysis and subsequent experiments, three types of mechanism and failure modes define the seismic behavior of unreinforced structural masonry walls when subjected to in-plane loads. The mechanisms depend on the geometry of the wall (height/width ratio) and quality of materials, but also on boundary restraints and loads acting on the wall (Figure 9-2) (Tomažević, 2000).

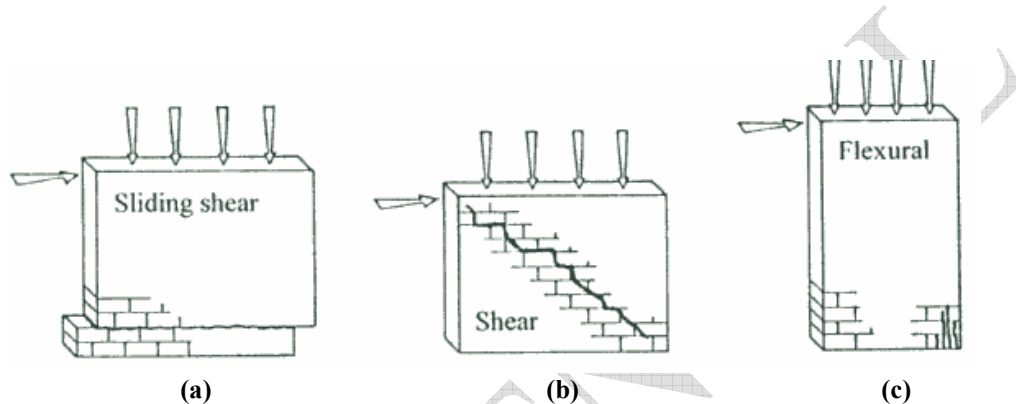

**Figure 9-2: Typical failure modes for unreinforced masonry walls, subjected to in-plane loads: a) Sliding Shear failure; b) Shear failure; c) Flexural failure (Tomažević 2000)**

**Sliding shear failure:** occurs in the case of low vertical load and poor quality mortar. The seismic loads cause shearing of the wall in two parts and sliding of the upper part of the wall on one of the horizontal mortar joints (Figure 9-1 (a)).

**Diagonal cracking mode:** a typical mode of failure of masonry walls subjected to seismic loads. It takes place where the principal tensile stresses developed in the wall under a combination of vertical and horizontal loads exceed the tensile strength of masonry materials. Characteristic diagonal cracks develop in the wall just before the attainment of lateral resistance. The cracks can either follow the mortar joints or pass through the masonry units, or both.

**Flexural failure:** in the case of improved shear resistance and high moment/shear ratio crushing of compressed zones at the ends of the wall usually takes place.

### 9.1.3 Application of FRP materials for in-plane strengthening

In terms of design, masonry strengthened with externally bonded FRP systems may be treated following the procedure of modern design codes. Frequently the masonry strengthened with FRP materials is treated in the same manner as reinforced concrete

structures because of lack of specific knowledge (Triantafillou, 1998). More experimental tests and studies are needed to characterize the in-plane behavior of masonry walls strengthened with FRP, in particular to better understand the shear behavior. Further experimental tests would allow the development of specific analytical models for in-plane FRP strengthening of masonry walls.

The analysis of simple cases of FRP strengthened walls has led to the following conclusions (Bakis et al., 2002):

- In the case of in-plane bending, the amount and distribution of FRP reinforcement is of high importance: high reinforcement ratios placed near the highly stressed zones give a significant strength increase.
- The achievement of full in-plane flexural strength depends on the proper anchorage of the FRP reinforcement: short anchorage lengths and/or the absence of clamping at the laminate curtailment position may result in premature failure through peeling-off beneath the adhesive.
- The in-plane shear capacity of masonry walls strengthened with FRP may be quite high especially in the case of low axial loads.

The failure modes for FRP strengthened walls subject to in-plane loads can be summarized as follow:

**FRP debonding:** due to shear transfer mechanisms at the interface, masonry/FRP debonding may occur before flexural failure. Debonding starts from the shear cracks or from the horizontal flexural cracks as described in sections 9.1.1 and 9.1.2.

**Flexural failure:** can be either by rupture of the FRP laminate or masonry crushing. Typically, flexural failure in masonry walls strengthened at high reinforcement ratio is due to compressive crushing. FRP rupture is less desirable than masonry crushing being that the latter is a more ductile failure mode (Triantafillou, 1998). Both failure modes are acceptable in governing the design of in-plane loaded walls.

**Shear Failure:** can be either sliding shear failure or diagonal cracking mode. Such failure modes occur for low amounts of FRP reinforcement and they should be prevented with a proper design.

#### 9.1.4 Strengthening with GGRP

The recommendations given in this chapter apply only for rectangular cross-sections. The GGRP reinforcement is considered to be working only in tension, neglecting any compressive strength. The GGRP reinforcement can either be applied on one or both sides of the walls.

Based on the principles of capacity design, undesirable modes of failure in the masonry walls can be avoided. The application of GGRP reinforcement can modify the failure mode from brittle shear to flexural failure.

In the case of walls strengthened only on one side with either Carbon or Glass FRP laminates, experimental results obtained from diagonal tests conducted according to ASTM E 519-02, showed a negligible increment in the in-plane capacity (Valluzzi et al., 2002, Grando et Al., 2003). Such behavior is due to the bending deformations induced during the loading phases along the diagonal on the unreinforced side. The bending phenomenon is caused by the noticeable difference of stiffness of the two sides of the panel as a result of the asymmetrical reinforcement. This phenomenon however is not observed in the diagonal tests for walls strengthened with GGRP systems (Yu et al., 2004). This is due to the greater deformability of GGRP systems compared to common FRP technologies based on epoxy resin.

## 9.2 NON-LOAD BEARING WALLS STRENGTHENED WITH GGRP SYSTEMS

This section presents a design methodology for strengthening of masonry infill walls using GGRP systems in order to enhance their seismic response. The retrofitting technique aims at preventing the occurrence of undesirable modes of failure (i.e. sliding shear mode, diagonal cracking mode) allowing the corner crushing mode to control.

To facilitate the modeling procedure, the long known concept of the masonry infill wall acting as a diagonal strut connecting the two loaded corners will be adopted. This assumption has been verified by different researchers in the last five decades. Because of its practicality and ease of implementation in analysis, the diagonal strut concept will be utilized herein to present a method of analysis of masonry infill walls retrofitted with GGRP systems. The presence of the GGRP system is intended to prevent any shear failure. The increase in stiffness can be investigated by applying the diagonal strut concept, that is, the wall is acting as a diagonal strut connecting the two loaded corners.

The ultimate strength design criterion states that the design load capacity corresponding to crushing of the corner should be:

$$\phi R_{nC} \geq R_u \quad (9.1)$$

$$R_{nC} = P_{\varphi, nC} \cos \varphi \quad (9.2)$$

where  $R_{nC}$  is the nominal capacity related to the crushing of the corner,  $R_u$  is the ultimate in-plane load,  $P_{\varphi, nC}$  is the nominal strength of the equivalent strut related to the crushing of the corner, and  $\varphi$  is the angle to the horizontal of the strut defined as



$\phi = \tan^{-1} \frac{h}{l}$  (Figure 9-3). The capacity should be computed considering a reduction factor  $\phi=0.60$ .

This model is applicable only if all possible failure modes were suppressed except for the corner crushing mode, then the following relation should be verified:

$$R_{nC} < \min \begin{cases} R_{nS} \\ R_{nD} \end{cases} \quad (9.3)$$

being that  $R_{nS}$  is the nominal capacity related to sliding shear failure and  $R_{nD}$  is the nominal capacity related to diagonal cracking failure.

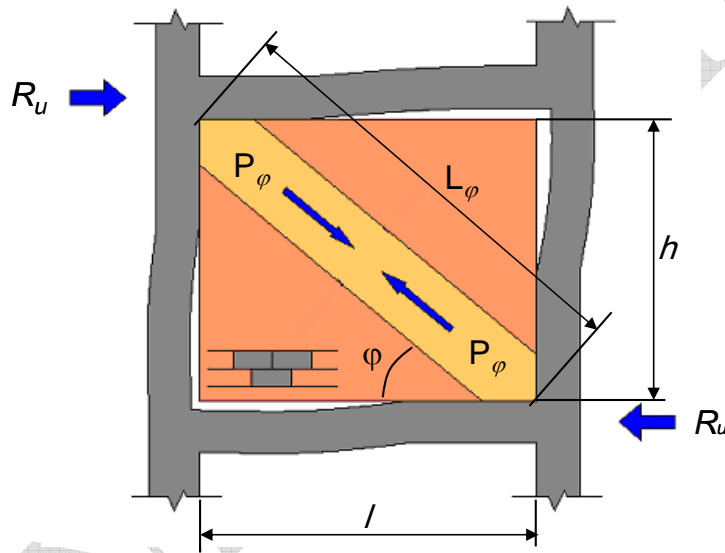

**Figure 9-3: Geometry of infill panel.**

In order to design the amount of GGRP reinforcement to suppress failure modes other than corner crushing, the capacity corresponding to such failure modes should be known.

The following sections describe: 1) A model developed to evaluate the strength of infill masonry walls failing in corner crushing mode; and 2) GGRP design requirements to prevent both the sliding shear and diagonal cracking failure mode.

### 9.2.1 Nominal corner crushing strength

Given the present state of GGRP technology validation, the computation of the nominal corner crushing strength,  $P_{\phi, nC}$ , for a retrofitted infill wall is only empirical. It consists of two steps:

- a) Computation of the  $P_{\phi, nC}$  for the unstrengthened wall;
- b) Increase of the value found in step a by a magnification factor of 1.3 or 1.5 for concrete or clay masonry, respectively.

The magnification factors listed have come from experimental evidence (Yu, 2004) after applying a safety factor of 1.5.

#### 9.2.1.1 Computation of $P_{\phi, nC}$ for unstrengthened URM infill walls

Applying the diagonal strut theory, the strength of the strut,  $P_{\phi, nC}$  (Figure 9-4), is given as a function of the ultimate compressive strength of the strut,  $f'_{m-\phi}$ , by equation (9.4):

$$P_{\phi, nC} = f'_{m-\phi} A_{\phi} \quad (9.4)$$

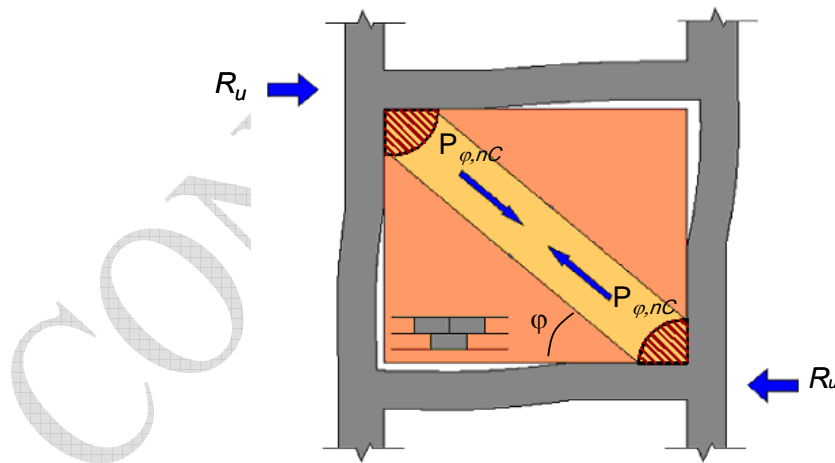

**Figure 9-4: Corner crushing failure of the equivalent strut**

The effective area of the wall,  $A_{\phi}$ , which, generally ranges between 10% and 25% of the frame column height multiplied by the thickness of the wall is given by equation (9.5).

$$A_\varphi = \frac{(1-\alpha_c)\alpha_c h t}{\cos \varphi} \quad (9.5)$$

where,  $\alpha_c$  is the ratio of the column contact length to the clear column height  $h$ . The parameter  $\alpha_c$  representing the ratio between the column-wall contact length and the column height is given by:

$$\alpha_c = \sqrt{\frac{2(M_{pj} + 0.2M_{pc})}{t f'_{m-0}}} \leq 0.4h \quad (9.6)$$

where,  $M_{pj}$  is the minimum of the plastic moment capacity of the column, the beam or the connection, referred to as the plastic moment capacity of the joint.  $M_{pc}$  is the column plastic moment capacity,  $f'_{m-0}$  is the specified compressive strength of the masonry wall parallel to the bed joint, and  $t$  is the thickness of the wall.

Due to the fact that the wall behaves as if it were diagonally loaded, constitutive relations of orthotropic plates are used to obtain the Young's modulus,  $E_\varphi$ , of the wall in the diagonal direction using the following equation:

$$E_\varphi = \frac{\alpha f'_m}{1.25 (\cos \varphi)^4 + 2(\cos \varphi \sin \varphi)^2 + (\sin \varphi)^4} \quad (9.7)$$

where,  $\alpha$  is defined as:

$$\alpha = \frac{E_m}{f'_m} \quad (9.8)$$

which, may be obtained from actual test data, information in the literature, or code recommendations. The ultimate compressive strength of the strut,  $f'_{m-\varphi}$ , can be determined as:

$$f'_{m-\varphi} = \frac{E_\varphi}{\alpha} \quad (9.9)$$

To evaluate the drift of the frame, the axial stiffness of the strut,  $K_\varphi$ , could be taken as:

$$K_\varphi = \frac{E_\varphi A_\varphi}{L_\varphi} \quad (9.10)$$

where  $E_\varphi$ ,  $A_\varphi$ ,  $L_\varphi$ , are the elastic modulus, the area and the length of the strut tilted at the angle  $\varphi$ , respectively.

### 9.2.2 Nominal shear sliding strength for strengthened walls

The ultimate nominal strength for the shear sliding failure mode capacity is computed as:

$$R_{nS} = V_{m,S} + V_{m,f} \quad (9.11)$$

And should be such that:

$$R_{nS} > R_{nC} \quad (9.12)$$

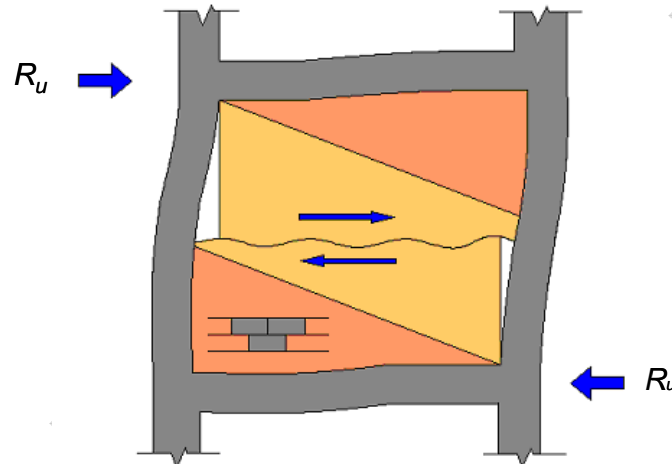

Figure 9-5: Sliding shear failure

The masonry shear capacity for a sliding failure (Figure 9-5),  $V_{m,S}$ , can be evaluated as the minimum of the failure criteria based on Mohr-Coulomb's theory or on the modified Turnšek-Čačovič's theory (Turnšek et al., 1971, Turnšek et. al., 1981) taking into account the results obtained in (Stafford Smith et al., 1978). According to equation 9.13,  $V_{m,S}$  is:

$$V_{m,S} = \min \left\{ \begin{array}{l} \left[ \tau_0 + \mu \left( 0.8 \frac{h}{l} - 0.2 \right) \frac{R_u}{lt} \right] \frac{lt}{1.43} \\ S_s(lt) \sqrt{1 + \frac{\left( 0.8 \frac{h}{l} - 0.2 \right) R_u}{1.5 S_s} \frac{lt}}{lt}} \end{array} \right. \quad (9.13)$$

where  $\tau_0$  is the cohesive strength at the bed joint and  $\mu$  is the coefficient of friction; these parameters can be determined by triplet test or from literature, or code recommendations. An indicative value for  $\tau_0$  can be  $\tau_0 = 0.03 f'_m$ , and for the friction can be  $\mu = 0.4$ .  $S_s$  is the shear resistance determined in accordance with ASTM E519-02. In the absence of such data, the shear resistance for masonry panels built with concrete blocks or clay bricks and mortar type O, N or S can be taken as 22 psi (0.15 MPa) (Eurocode 6 Section 3.6.2, 2004).

The shear resistance provided by the GGRP system,  $V_{m,f}$ , should be determined as specified in section 9.4.

### 9.2.3 Nominal diagonal cracking strength for strengthened walls

The ultimate nominal strength for the diagonal cracking failure mode capacity is computed as:

$$R_{nD} = V_{m,D} + V_{m,f} \quad (9.14)$$

and should be such that:

$$R_{nD} > R_{nC} \quad (9.15)$$

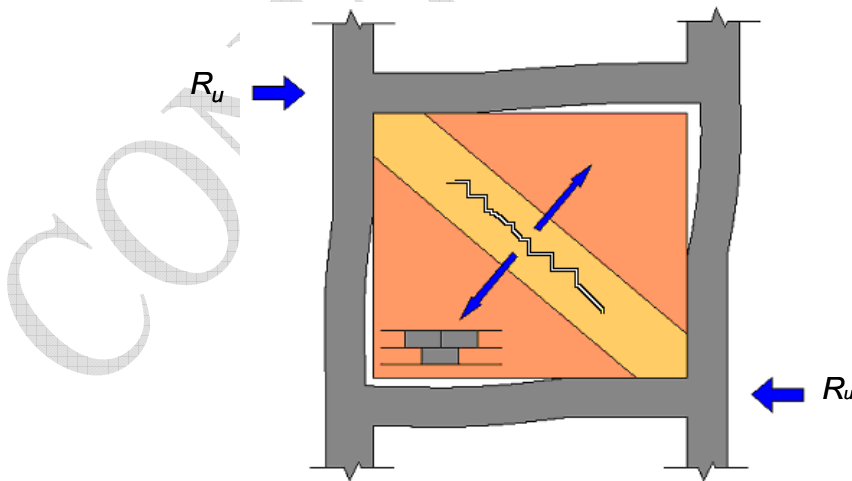

**Figure 9-6: Diagonal cracking failure**

The masonry shear capacity for a diagonal cracking failure,  $V_{m,D}$ , can be evaluated as indicated in Equation (9.16) (Stafford Smith et al., 1978):

$$V_{m,D} = \frac{S_s l t}{0.6} \quad (9.16)$$

The shear resistance provided by the GGRP system,  $V_{m,f}$ , should be determined as specified in the section 9.4.

### 9.3 LOAD BEARING WALLS STRENGTHENED WITH GGRP SYSTEMS

#### 9.3.1 Nominal flexural strength

When considering flexural capacity, GGRP rupture is less desirable than masonry crushing being that the latter is a more ductile failure mode. Both failure modes are acceptable in governing the design for the flexural behavior of in-plane walls reinforced with GGRP. When possible, the nominal flexural capacity should be smaller than the shear strength. The recommendations given in this chapter are for walls with a rectangular cross-section and consider the reinforcement is working only in tension.

The ultimate strength design criteria state the design flexural capacity of a member subject to flexural and axial load should be:

$$\frac{P_u}{\phi P_n} + \frac{M_u}{\phi M_n} \leq 1 \quad (9.17)$$

The computations are based on the equilibrium of force and strain compatibility based on assumption given in section 8.2.1. The distribution of strain and stress in the GGRP reinforced masonry for a rectangular cross-section under in-plane and axial load are shown in Figure 9-7. The stress block parameters  $\beta_1$  and  $\gamma$  associated with a parabolic distribution are given in section 7.2.2.

The nominal axial strength  $P_n$  should be evaluated according to the Building Code Requirements for Masonry Structures (ACI 530-02/ASCE 5-02/TMS 402-02), and shall not exceed the values given in Eq. (8.17) or Eq. (8.18).

As indicated in Figure 9-7-c, in all calculations the tensile contribution of the GGRP is limited to the layers of laminate further away from the compression zone. The contribution of the other laminates subject to tension could be included if desirable.

Using the stress distribution for a cracked masonry cross-section subject to flexural and axial load, the equations of equilibrium and compatibility are given as:

$$(\gamma f'_m)(\beta_1 c)t - P_u = 2A_f f_f \quad (9.18)$$

$$M_n = (\gamma f'_m)(\beta_1 c)t \left( \frac{l}{2} - \frac{\beta_1 c}{2} \right) + 2A_f f_f \left( d - \frac{l}{2} \right) \quad (9.19)$$

$$\frac{\epsilon_m}{c} = \frac{\epsilon_f}{d-c} = \frac{\epsilon_m + \epsilon_f}{d} \quad (9.20)$$

where  $M_n$  and  $P_n$  are related to the center of gravity,  $G$  of the uncracked cross-section.

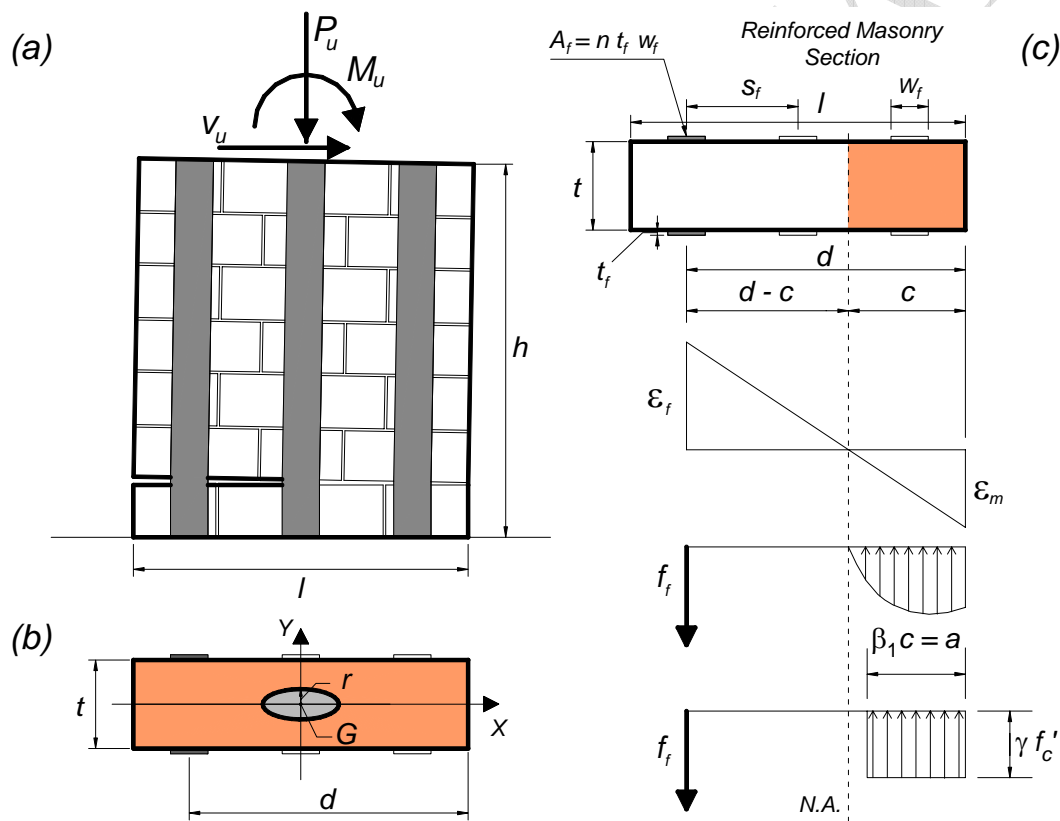

**Figure 9-7: Wall under in-plane loads, (a) forces acting on the wall, (b) geometric parameters of the uncracked section, (c) internal strain and stress distribution for a horizontal rectangular section**

Alternatively for the moment  $M_n$  the following equations can be used:

$$M_n = (\gamma f'_m)(\beta_1 c)t \left( d - \frac{\beta_1 c}{2} \right) - P_u \left( d - \frac{l}{2} \right) \quad (9.21)$$

$$M_n = 2A_f f_f \left( d - \frac{\beta_1 c}{2} \right) + P_u \left( \frac{l}{2} - \frac{\beta_1 c}{2} \right) \quad (9.22)$$

To prevent masonry shear failure the nominal masonry shear capacity,  $V_n$ , can be evaluated according to section 9.3.2.

### 9.3.1.1 Failure mode

The flexural capacity of a GGRP load bearing wall is dependent on the failure mode which can be governed by masonry crushing or GGRP rupture/debonding. The failure mode can be determined by comparing the GGRP reinforcement ratio (Eq. (9.23)) to the balanced reinforcement ratio (Eq. (9.24)), determined according to equilibrium and compatibility.

$$\Theta_f = \frac{A_f}{td} \quad (9.23)$$

$$\Theta_{fb} = \frac{f_m'}{f_{fe}} \left[ \gamma \beta_1 \frac{\varepsilon_{mu}}{\varepsilon_{mu} + \varepsilon_{fe}} - \frac{P_u}{td f_m'} \right] = \frac{f_m'}{f_{fue}} \left[ \gamma \beta_1 \frac{E_f \varepsilon_{mu}}{E_f \varepsilon_{mu} + f_{fe}} - \frac{P_u}{td f_m'} \right] \quad (9.24)$$

If the reinforcement ratio is below the balanced ratio ( $\Theta_f < \Theta_{fb}$ ), GFRP rupture/debonding failure mode governs. Otherwise, ( $\Theta_f > \Theta_{fb}$ ) masonry crushing governs. It has to be noted that a different symbol from chapter 8 was introduced for the reinforcement ratio since it refers to a different cross-section.

### 9.3.1.2 Nominal flexural capacity

Masonry crushing failure:

When  $\Theta_f > \Theta_{fb}$ , the failure is initiated by crushing of the masonry, and the stress distribution in the masonry given in section 7.2.2 can be approximated with a rectangular stress block defined by the parameters  $\beta_1$  and  $\gamma$  given in Table 7-2. Based on the equations (9.18) to (9.20) the following equations can be derived:

$$M_n = (\gamma f_m') at \left( d - \frac{a}{2} \right) - P_u \left( d - \frac{l}{2} \right) = A_f f_f \left( d - \frac{a}{2} \right) + P_u \left( \frac{l}{2} - \frac{a}{2} \right) \quad (9.25)$$



$$a = \beta_1 c = \frac{(A_f f_f + P_u)}{\gamma f_m' t} \quad (9.26)$$

$$f_f = E_f \varepsilon_{mu} \frac{\beta_1 d - a}{a} \quad (9.27)$$

Considering Eq. (9.18) to Eq. (9.20), in the case of masonry crushing, the following values for  $f_f$  and  $c$  can be obtained:

$$f_f = \left( \sqrt{\left( \frac{E_f \varepsilon_{mu}}{2} - \frac{P_u}{2A_f} \right)^2 + \left( \frac{\gamma \beta_1 f_m' - \frac{P_u}{A_f}}{\Theta_f} \right) E_f \varepsilon_{mu} - \left( \frac{E_f \varepsilon_{mu}}{2} + \frac{P_u}{2A_f} \right)} \right) \leq f_{fue} \quad (9.12)$$

$$c = \frac{a}{\beta_1} = \frac{\Theta_f d}{\beta_1 \gamma f_m'} \left[ \sqrt{\left( \frac{E_f \varepsilon_{mu}}{2} - \frac{P_u}{2A_f} \right)^2 + \frac{\beta_1 \gamma f_m'}{\Theta_f} E_f \varepsilon_{mu} - \left( \frac{E_f \varepsilon_{mu}}{2} - \frac{P_u}{2A_f} \right)} \right] \quad (9.29)$$

GGRP debonding or failure:

When  $\Theta_f < \Theta_{fb}$ , the failure of the wall is initiated by rupture/debonding of the GGRP system, and the equivalent stress block depends on the maximum strain reached by the masonry. In this case an iterative process should be used to determine the equivalent stress block, because the analysis incorporates four unknowns after the determination of  $P_u$ .

Alternatively, according to the Building Code Requirements for Masonry Structures (ACI 530-02/ASCE 5-02/TMS 402-02) a value of  $\beta_1$  and  $\gamma$  equal to 0.8 can be assumed.

### 9.3.2 Nominal shear strength

The design shear strength for in-plane wall shall be in accordance with Eq. (9.30), where  $\phi$  is defined in section 7.3.2.

$$\phi V_n \geq V_u \quad (9.30)$$

The nominal shear capacity can be evaluated as:

$$V_n = V_m + V_{m,f} \quad (9.31)$$

The masonry shear capacity,  $V_m$ , can be evaluated by the equation (9.32) as show below, considering the minimum of masonry shear resistance related to shear sliding failure and shear diagonal failure (Magenes et al., 1997).

$$V_m = t l \tau_u \quad (9.32)$$

where the ultimate mean shear stress  $\tau_u$  can be calculated as:

$$\tau_u = \min \begin{cases} \tau_{v,S} \\ \tau_{v,D} \end{cases} \quad (9.33)$$

being  $\tau_{v,S}$  the shear resistance related to diagonal cracking associated with mortar bed and head joint failure and  $\tau_{v,D}$  is the shear resistance related to diagonal cracking associated with the splitting of the concrete blocks or clay bricks.  $\tau_{v,S}$  and  $\tau_{v,D}$  can be evaluated as follows:

$$\tau_{v,S} = \min \begin{cases} \tau_{c,S} = \frac{\tau_0 + \mu p}{1 + \frac{M}{Vd}} \\ \tau_{w,S} = \frac{1.5 \tau_0 + \mu p}{1 + 3 \frac{\tau_0 M}{p Vd}} \end{cases} \quad (9.34)$$

$$\tau_{v,D} = \frac{f_{bt}}{2.3 \left(1 + \frac{M}{Vd}\right)} \sqrt{1 + \frac{p}{f_{bt}}} \quad (9.35)$$

where:

$$p = \frac{P_u}{t l} \quad (9.36)$$

$$\frac{M}{Vd} \leq 1.0 \quad (9.37)$$

and  $\tau_{c,S}$  is the shear stress relevant to the whole section,  $\tau_{w,S}$  is the shear stress relevant to the cracked section,  $\tau_0$  is the cohesive strength at the bed joint and  $\mu$  is the coefficient of friction. These parameters can be determined by triplet test or from literature, or code recommendations. An indicative value for  $\tau_0$  can be  $\tau_0 = 0.03 f'_m$ , and for the friction can be  $\mu = 0.4$ .  $f_{bt}$  is the tensile strength of the blocks or bricks.

The equation (9.31) should respect the limit imposed in section 8.2.4 from the points (a), (b), (c) and the equations (8.37) and (8.38), where the shear strength provided by the masonry,  $V_m$ , should be computed using Eq. (9.32) instead of equations provided by the Building Code Requirements for Masonry Structures (ACI 530-02/ASCE 5-02/TMS 402-02).

The shear resistance provided by the GGRP system,  $V_{m,f}$ , should be determined as specified in section 9.4.

#### 9.4 SHEAR RESISTANCE PROVIDED BY THE GGRP SYSTEM

The shear resistance provided by the GGRP system can be determined as:

$$V_{m,f} = A_f f_{fe,\omega} \quad (9.38)$$

where  $A_f$  is the total area of GGRP reinforcement perpendicular to the shear crack and  $f_{fe,\omega}$  is the effective stress in the GGRP reinforcement.

Equation (9.38) can be used interchangeably when the GGRP reinforcement is either on one or both sides and when placed in horizontal or vertical directions or both.

The effective stress  $f_{fe,\omega}$ , and the corresponding effective strain  $\varepsilon_{fe,\omega}$ , are computed as:

$$f_{fe,\omega} = k_{v,\omega} f_{fu} \quad (9.39)$$

$$\varepsilon_{fe,\omega} = k_{v,\omega} \varepsilon_{fu} \quad (9.40)$$

Equation (9.38) can be written as:

$$V_{m,f} = A_f E_f \varepsilon_{fe,\omega} = k_{v,\omega} A_f f_{fe} \quad (9.41)$$

The parameter  $k_{v,\omega}$  accounts for the orientation angle of the fibers with respect to the direction of the failure surface opening. The most common angles,  $\omega$ , are  $0^\circ$ ,  $45^\circ$  and  $90^\circ$  (for fibers parallel, tilted and perpendicular to the opening direction of the fracture). The parameter  $k_{v,\omega}$  should be determined experimentally and related to the specific GGRP and masonry wall involved in the field application. Conservatively, it can be assumed  $k_{v,\omega} = 0.5$ ; such value was calibrated based on the experimental tests (Yu et al., 2004).

The parameter  $k_{v,\omega}$  could be set equal to 0.5 when the anchor length,  $l_a$ , equal or bigger than the effective length,  $l_e$ , is provided, as indicated in Figure 9-8.

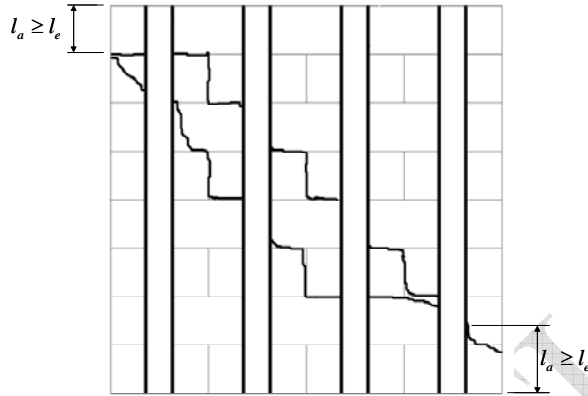
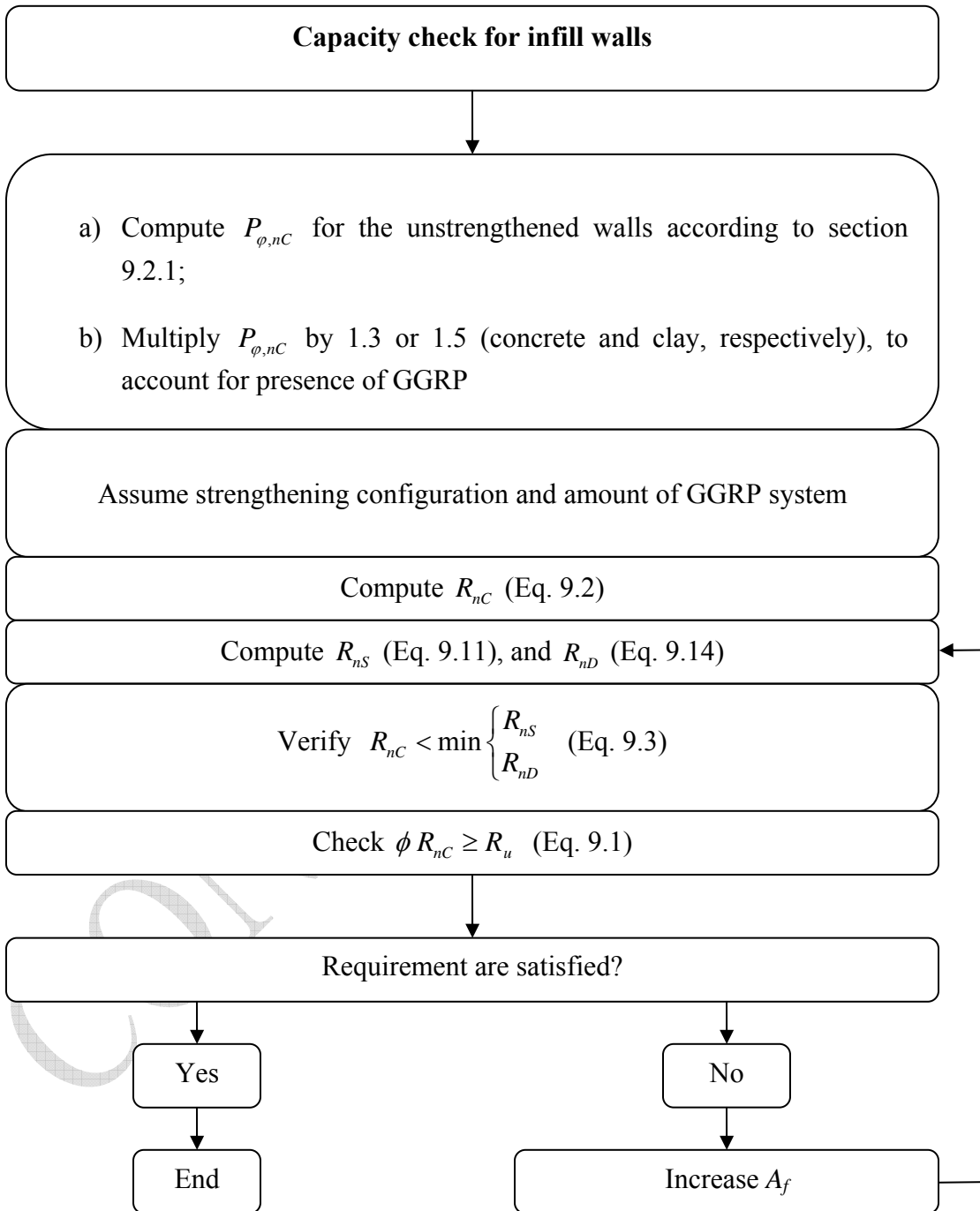

**Figure 9-8: Minimum anchor length needed for shear design**

The shear resistance provided by the GGRP system,  $V_{m,f}$ , should be within the limitations provided in sections 7.3.1 and 9.3.2.

CONFIDENTIAL

9.5 COMPUTATION PROCEDURE FOR INFILL WALLS



## 9.6 COMPUTATION PROCEDURE FOR SHEAR WALLS

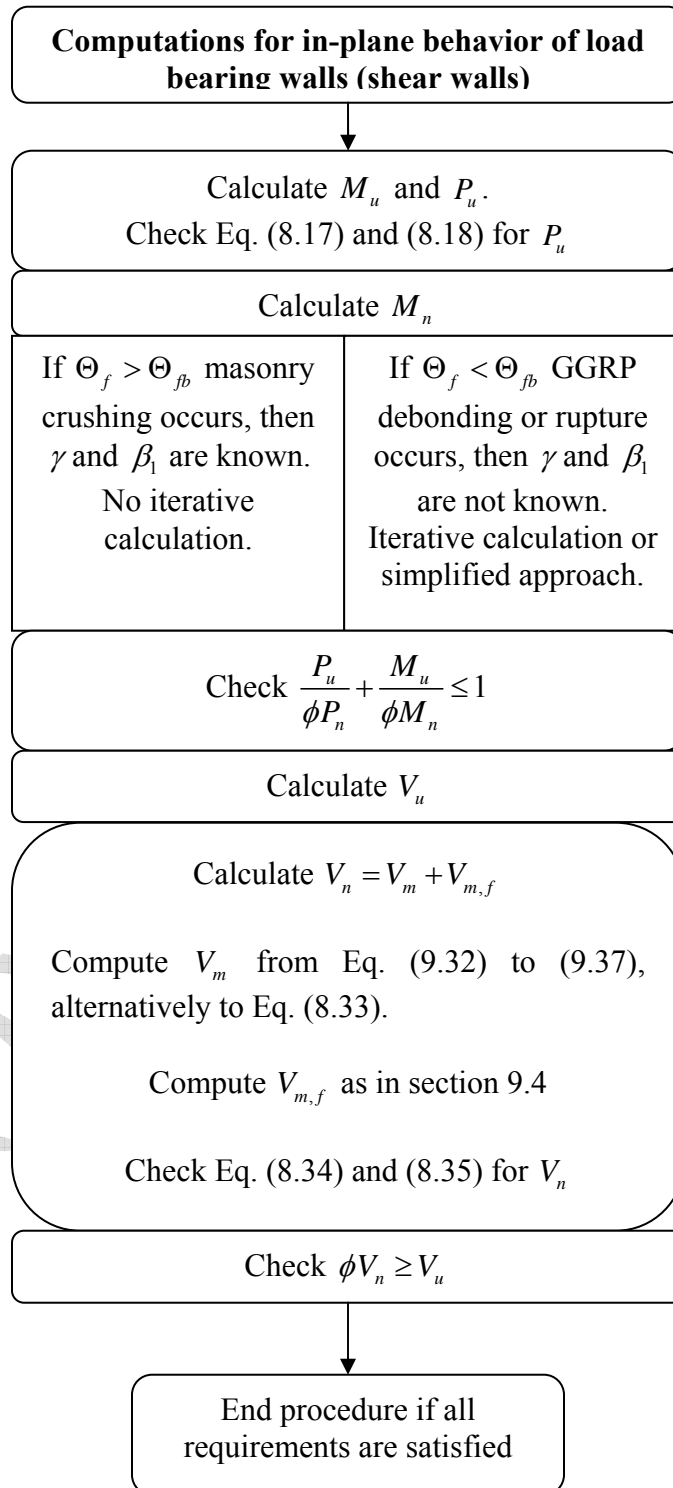

## CHAPTER 10 DETAILING CONSIDERATIONS

### 10.1 GGRP REINFORCEMENT

#### 10.1.1 Minimum area of GGRP reinforcement

In reinforced masonry members where reinforcing GGRP system is provided to enhance the strength in the plane of the member, the area of main GGRP system should not be less than 0.05 % of the cross-sectional area of the member, taken as the product of its effective width,  $l$ , and its effective depth,  $t$ .

In walls where reinforcing GGRP is provided to enhance resistance to lateral loads, the total area of such reinforcement should not be less than 0.03 % of the cross-sectional area of the wall (i.e. 0.015 % in each face).

Where shear reinforcing GGRP is required in the member, the area of shear GGRP reinforcement should not be less than 0.05 % of the cross-sectional area of the member.

#### 10.1.2 Maximum spacing of GGRP reinforcement

The GGRP reinforcement strips should be distanced to each other according to equation 10.1 (CNR DT, 2004, Eurocode 6, 2004, ACI 440.2R-02, 2002):

$$(s_f - w_f) \leq 3t \quad (10.1)$$

where  $t$  is the thickness of the masonry panel,  $w_f$  and  $t_f$  are the width and the thickness of the GGRP strips, respectively (See Figure 10-1):

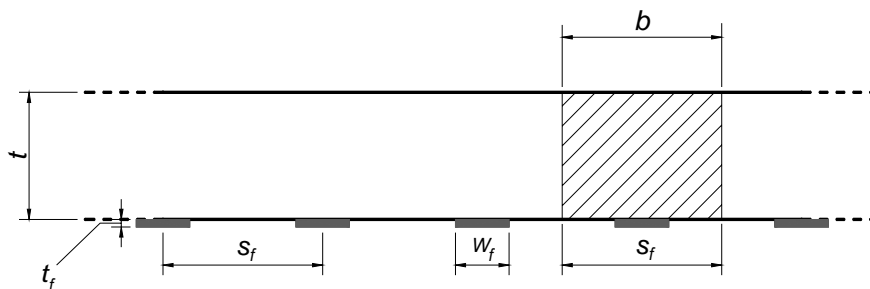

Figure 10-1: Geometric dimensions for a reinforced masonry section

## 10.2 ANCORAGE LENGTH

### 10.2.1 Out-of-plane

The GGRP strips should be correctly anchored at its ends using a minimum anchor length,  $l_a$ , equal to the effective adhesion length  $l_e$  and computed according to Appendix III.

In absence of any experimental and analytical evaluation, the GGRP Strengthening should be extended from support to support.

### 10.2.2 In-Plane

#### 10.2.2.1 Non-Load Bearing Walls

Experimental studies showed that for non-bearing walls the anchorage length to be provided can be limited to 4 in (Yu, 2004). Figure 10-2 shows the minimum anchorage length to be provided to assure a correct shear behavior of the masonry wall under in-plane actions.

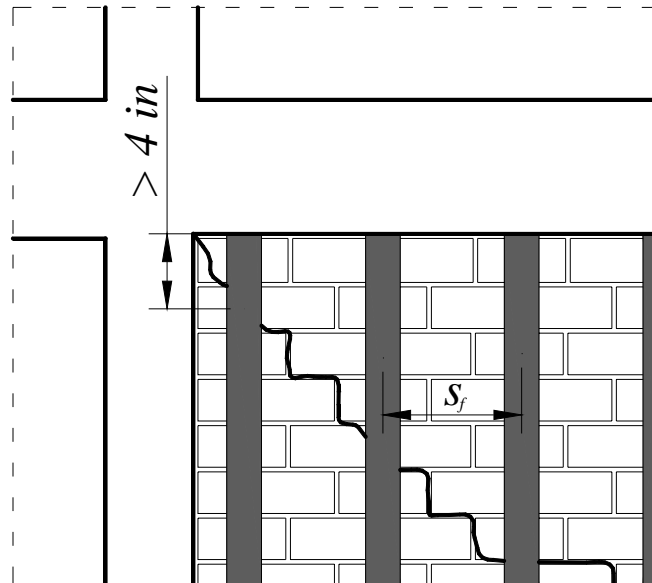

**Figure 10-2: Minimum length of anchoring that should be assured to provide a correct shear behavior**



### 10.2.2.2 Load Bearing Walls

The GGRP strips should be correctly anchored at its ends using a minimum anchor length,  $l_a$ , equal to the effective adhesion length  $l_e$  and computed according to Appendix I.

In absence of any experimental and analytical evaluation, the GGRP Strengthening should be extended from support to support.

### 10.3 CONTINUITY WITH FRAME

When GGRP continuity with adjacent frame members is necessary, a possible detailing solution is showed in Figure 10-3. The anchoring of the GGRP system to the reinforced concrete frame is created by overlapping the GGRP strengthening with Near Surface Mounted (NSM) bars. The bar inside the groove should have the same stiffness of the GGRP strips:  $A_{f,strips} E_{f,strips} = A_{f,rod} E_{f,rod}$ . The overlapping length should be at least 12 in, and the anchor length for the bar should be calculated according to ACI 440.1R-03 (chapter #11) and to ACI 318R-02 (appendix D).

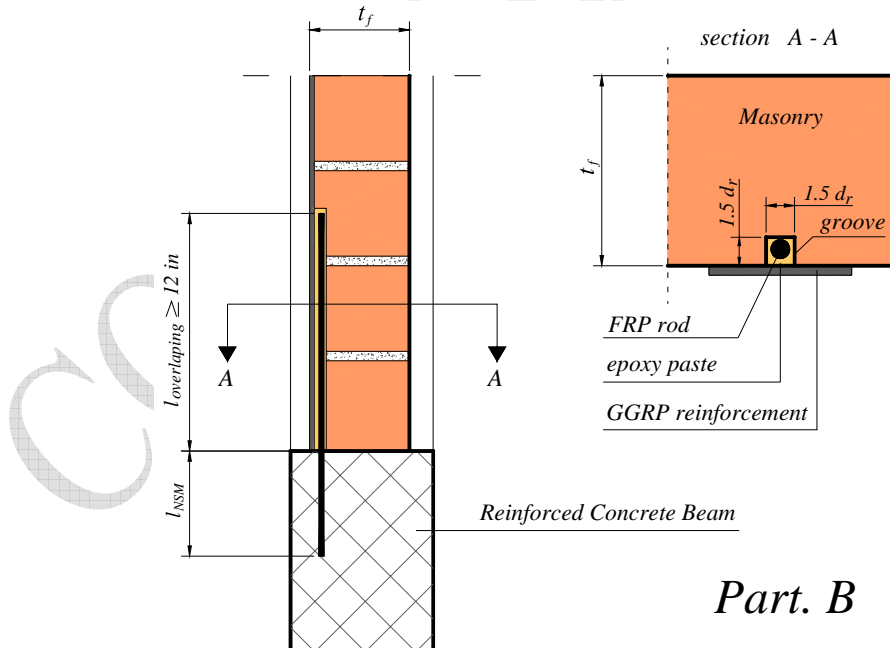

**Figure 10-3: Overlapping of the GGRP system with NSM technique to anchor the strips to the RC frame**

## 10.4 WALLS WITH OPENING

Existing masonry buildings constitute a large portion of the building stock throughout the world. Many of these buildings are located in earthquake endangered regions and might contain structural components, for example, unreinforced masonry (URM) walls that do not meet requirements such as load-carrying capacity and ductility. Furthermore, walls are usually built with openings for doors and/or windows which are expected to influence the load carrying capacity and mode of failure of the wall. Thus, there a need to investigate the ability of strengthening URM walls with openings to meet structural safety requirements and function requirements (Li et al., 2004).

In lightly reinforced and unreinforced masonry walls, such as concrete masonry units and brick, FRP material systems have demonstrated several benefits by adding shear and flexural resistance to the in-plane and out-of-plane strength and by improving the ductility of the walls (Ghobarah et al., 2004).

Glass FRP (GFRP) composites were more preferable than other types of fibers in masonry strengthening not only because of its lower cost but also because of its lower modulus of elasticity, which is compatible with masonry and may avoid premature reinforcement delamination after masonry cracking (Li et al., 2004).

Based on experimental results for out-of-plane walls with an opening the following was observed (Ghobarah et al., 2004):

- The strengthened walls sustained lateral load of the order of five times that of the unstrengthened URM wall, behaved in a ductile manner and dissipated a significant amount of energy due to cracking along the mortar joints and movement between masonry blocks.
- The FRP strengthening system is much simpler than using steel reinforcement and can be applied to walls that have been already damaged without the need of repairing cracked mortar joints before applying FRP.
- Framing of openings with FRP reduces the negative effects of openings on the lateral load capacity and improves the performance of the walls.
- Proper anchoring of the ends of the FRP laminates was found to be important in preventing debonding of the FRP
- The presence of openings in walls reduces the out-of-plane load carrying capacity.
- The FRP strengthening systems can increased the ductility of the walls by approximately 10-fold compared to the unstrengthened walls.

For in-plane walls the following was observed (Li et al., 2004):

- The FRP composites are efficient in improving the performance of URM walls for in-plane loads.
- Horizontal reinforcement in the spandrels did not show apparent contribution to the strength and ductility of the wall. Vertical reinforcement in the piers significantly

increased the stiffness, maximum lateral load-carrying capacity and energy dissipation capacity of URM walls. However, it impaired the maximum displacement capacity.

- Strengthening with a combination of horizontal reinforcement in the spandrels and vertical reinforcement in the piers significantly improved the overall structural behavior of URM walls including lateral load-carrying capacity, stiffness, energy dissipation capacity and maximum displacement capacity.

CONFIDENTIAL

## CHAPTER 11 FUTURE RESEARCH

Future research is necessary in areas that are still understudied or in areas that need additional evidence. The list of topics presented in this section has the purpose of providing a summary of future research topics related to the reinforcement of masonry structures with GGRP systems.

Materials:

- tensile strength of a population of GGRP systems
- determination of the shear modulus,  $G$ , of the GGRP system
- methods of fireproofing GGRP systems
- behavior of GGRP strengthened members under elevated temperatures
- effect of coefficient of thermal expansion between GGRP systems and member substrates
- creep-rupture behavior and endurance times of GGRP systems
- strength and stiffness degradation of GGRP systems in harsh environments

Flexure/axial force:

- ability to increase masonry wall flexural capacity by reinforcing the wall with externally bonded GGRP systems for out-of-plane and in-plane loads
- interaction of axial and flexural capacity of masonry walls retrofit with FRP systems
- effects of arching mechanism and crushing at the supports with respect to flexural retrofit with GGRP systems
- effect of multi-wythe walls on the ability to increase flexural capacity with GGRP systems

Shear:

- determination of failure modes of masonry shear walls retrofitted with externally bonded GGRP systems
- effect of multi-wythe walls on the ability to increase shear capacity with GGRP systems

Detailing:

- determination of appropriate bond dependent coefficients,  $k_m$ , to determine the development length and flexural moment capacity of masonry elements reinforced with externally bonded GGRP systems
- effect of masonry moisture absorption in determining bond characteristics and development length
- effect of filled and unfilled masonry mortar beds in the determination of bond characteristics and development length

- effect of a composite masonry wall, including masonry and mortar, in determining bond characteristics and development length
- effect of masonry texture in determining bond characteristics and development length;
- effect of out-of-plane variations between masonry units in determining bond characteristics and development length
- bond characteristics and related bond-dependent coefficients
- performance of mechanical anchorages for GGRP system when anchored into masonry and mortar beds

Structural systems and elements:

- ability to reinforce chimneys and other slender masonry structures, particularly when subject to heat and exhaust
- ability to reinforce masonry arch systems including masonry arch bridges
- ability to increase blast resistance of masonry walls

Effect of mortar beds, masonry texture, difference in stiffness between mortar and masonry, masonry strength, ductility of masonry, thermal coefficients and effect of moisture absorption on GGRP bond should be evaluated to determine the effect of the masonry characteristics on the development of the GGRP system.

## CHAPTER 12 REFERENCES

### 12.1 CITED REFERENCES

- Angel R., Abrams D.P., Shapiro D., Uzarski J., Webster, M. (1994), “Behavior of Reinforced Concrete Frames with Masonry Infills.” Struct. Res. Ser. 589, Department of Civ. Engrg., University of Illinois at Urbana-Champaign, IL.
- ACI 440M Guide Draft-1 (2004), “Guide for the Design and Construction of Externally Bonded FRP System for Strengthening Unreinforced Masonry Structures”, Reported by ACI Committee 440, 2004
- 440.1R-03 (2003), “Guide for the Design and Construction of Concrete Reinforcement with FRP Bars”, Reported by ACI Committee 440, 2003.
- ACI 440.2R-02 (2002), “Guide for the Design and Construction of Externally Bonded FRP Systems for Strengthening Concrete Structures”, Reported by ACI Committee 440, 2002
- ASTM E519-02 (2002), “Standard Test Method for Diagonal Tension (Shear) in Masonry Assemblages”, ASTM International, [www.astm.org](http://www.astm.org)
- Bakis C.E., Bank L.C., Brown V.L., Cosenza E., Davalos J.F., Lesko J.J., Machida A., Rizkalla S.H., Triantafillou T.C. (2002), “Fiber-Reinforced Polymer Composites for Construction – State-of-the-Art Review”, Journal of Composites for Construction, Vol. 6, No. 2, May 2002, pp. 73-87
- CNR-DT 200/2004 (2004), “Istruzioni per la Progettazione, l’Esecuzione ed il controllo di Interventi di Consolidamento Statico mediante l’utilizzo di Compositi Fibrorinforzati, Materiali, strutture in c.a. e in c.a.p., strutture murarie”, final Draft, Rome CNR 13 July 2004 (in italian)
- Carney, P. W. (2003), “Out of plane static and blast resistance of unreinforced masonry wall connections strengthened with fiber reinforced polymers,” Thesis (M.S.), University of Missouri - Rolla
- Dally, J. W., and Riley, W. F., 1991, Experimental Stress Analysis, Third Edition, McGraw Hill, New York, N.Y.
- Ehasani M.R., Saadatmanesh H. (1996), “Seismic Retrofit of UMR Walls with Fibers Composites”, The Masonry Society Journal, Vol. 14, No. 2, pp. 63-72
- Eurocode 6 (2004), “Design of masonry structures, Part 1-1: Common rules for reinforced and unreinforced masonry structures”, CEN European Committee for Standardization, final draft prEN 1996-1-1, April 2004.
- Fib Bulletin 14 (2001), “Externally bonded FRP reinforcement for RC structures”, Technical report on the Design and use of externally bonded fibre reinforced polymer reinforcement (FRP EBR) for reinforced concrete structures, Task Group 9.3 FRP (Fibre Reinforced Polymer) reinforcement for concrete structures, Fib (Federation Internationale du Beton), July 2001
- Galati N. (2002), “Arching effect in masonry walls reinforced with fiber reinforced polymer (FRP) materials,” Thesis (M.S.), University of Missouri - Rolla

- Galati N., Tumialan J.G., La Tegola A., and Nanni A. (2002), "Influence of Arching Mechanism in Masonry Walls Strengthened with FRP Laminates," ICCI 2002, San Francisco, CA, June 10-12, 10 pp. CD-ROM
- Ghobarah A., Mandooh Galal K. El (2004), "Out-of-Plane Strengthenig of Unreinforced Masonry Walls with Opening", *Journal of Composites for Construction*, Vol. 8, No. 4, August 1, 2004, pp. 298-305
- Grando S., Valluzzi M.R., Tumialan J.G., Nanni A. (2003), "Shear Strengthening of UMR Clay Walls whit FRP Systems", 6<sup>th</sup> International Symposium on Fiber-Reinforced Polymer (FRP) Reinforced for Concrete Structures (FRPRCS-6), Singapore, 8-10 July 2003
- Hamilton H.R., Dolan C.W. (2001), "Flexural Capacity of Glass FRP Strengthened Concrete Masonry Walls", *Journal of Composites for Construction*, Vol. 5, No. 3, August 2001, pp. 170-178
- Hamoush S., McGinley M., Mlakar P., Terro M.J. (2002), "Out-of-Plane behavior of surface-reinforced masonry walls", *Construction and Building Materials*, Vol. 16, Is. 6, pp. 341-351
- Karbhari V.M., Chin J.W., Hunston D., Benmokrane B., Juska T., Morgan R., Lesko J.J., Sorathia U., Reynaud D. (2003), "Durability Gap Analysis for Fiber-Reinforced Polymer Composites in Civil Infrastructure", *Journal of Composites for Construction*, Vol. 7, No. 3, August 1, 2003, pp. 238-247
- Li T., Galati N., Nanni A. (2004), "In-Plane Resistance of UMR Walls with Opening Strengthened by FRP Composites", *Advance Composites Materials in Bridges and Structures*, Calgary, Alberta, July 20-23, 2004, 10 pp., CD-ROM
- Magenes G., Calvi G.M. (1997), "In-plane seismic response of brick masonry walls", *Earthquake Engineering & Structural Dynamics*, Vol. 26, 1997, pp. 1091-1112
- MIL-17, 1999, *Guidelines for Characterization of Struc-tural Materials*, Composite Materials Handbook, V. 1, Rev. E, June 1999.
- Mutsuyoshi, H.; Uehara, K.; and Machida, A., 1990, "Mechanical Properties and Design Method of Concrete Beams Reinforced with Carbon Fiber Reinforced Plastics," *Transaction of the Japan Concrete Institute*, Japan Concrete Institute, Tokyo, Japan, V. 12, pp. 231-238.
- Nanni, A., "North American Design Guidelines for Concrete Reinforcement and Strengthening using FRP: Principles, Applications, and Unresolved Issues," *Construction and Building Materials*, Vol. 17, No. 6-7, Sept.-Oct. 2003, pp. 439-446.
- Stafford Smith B., Riddington J.R. (1978), "The design of masonry infilled steel frames for bracing structures. *The Structural Engineer*, n. 1, v. 56B, p. 1-7.
- Tomažević M. (2000), "Earthquake-Resistant Design of Masonry Buildings", Ed. Elnashai A.S. & Dowling P.J., Imperial College Press
- Triantafillou T.C. (1998), "Strengthening of Masonry Structures Using Epoxy-Bonded FRP Laminates", *Journal of Composites for Construction*, Vol. 2, No. 2, May 1998, pp. 96-103
- Tumialan J.G., Galati N., Nanni A. (2003-a), "FRP Strengthening of UMR Walls Subject to Out-of-Plane Loads", *ACI Structures Journal*, Vol. 100, No. 3, May-June, pp.312-329

- Tumialan J.G., Galati N., Nanni A. (2003-b), "Field Assesment of Unreinforced masonry Walls Strengthened with Fiber Reinforced Polymer laminates", Journal of Structural Engineering, Vol. 129, No. 8, August 2003, pp. 1047-1055
- Turnšek V., Čačovič F. (1971), "Some experimental results on the strength of brick masonry walls", Proc. 2<sup>nd</sup> Int. Brick-Masonry Conf. (British Ceramic Society, Stoke-on-Trent), 1971, pp. 149-156
- Turnšek V., Sheppard P. (1981), "The shear and flexural resistance of masonry walls", Proc. of Int. Research Conf. on Earthquake Engineering (IZIIS, Skopje), 1981, pp. 517-573
- Valluzzi M.R., Tinazzi D., Modena C. (2002), "Shear behavior of masonry panels strengthened by FRP laminates", Construction and Building Materials, Vol. 16, pp. 109-416
- Yu P., Silva P.F., Nanni A. (2004), "Application of Bondo Polyurea in Structural Strengthening of RC Beams and UMR Walls", Final Report, Report No. CIES 01-49, Center for Infrastructure Engineering Studies, University of Missouri-Rolla, August 2004

## 12.2 OTHER REFERENCES

- Albert M.L., Elwi A.E., Cheng J.J.R. (2001), "Strengthening of unreinforced masonry walls using FRPs", Journal of Composites for Construction, Vol. 5, No. 2, May, 2001, pp. 76-84
- Alvarenga R. (2002), "ANÁLISE TEÓRICO-EXPERIMENTAL DE ESTRUTURAS COMPOSTAS DE PÓRTICOS DE AÇO PREENCHIDOS COM ALVENARIA DE CONCRETO CELULAR AUTOCLAVADO, Ph.D Thesis, Escola de Engenharia de São Paulo, Carlos-Universidade de São Paulo, 2002, <http://www.civil.uminho.pt/masonry/PhDTheses.htm>
- Beconcini M.L., Buratti G. (1999), "Influenza dei pannelli di tamponamento sul comportamento degli edifici intelaiati", Costruire in Laterizio, Vol. 70, July-August, 1999, pp. 58-63, in italian
- Borri A., Corradi M., Vignoli A. (2001), "Il Problema della Valutazione della Resistenza a Taglio della Muratura mediante Prove Sperimentali", X Congresso Nazionale "L'ingegneria Sismica in Italia", Potenza-Matera, 9-13 September, 2001, CD-ROM, in italian.
- Borri A., Corradi M., Vignoli A. (2004), "Nuove sperimentazioni per la valutazione della resistenza a taglio delle murature prima e dopo il rinforzo", XI Congresso Nazionale "L'ingegneria Sismica in Italia", Genova, 25-29 January, 2004, CD-ROM, in italian.
- Borri A., Giannantoni A. (2004), "esempi di utilizzo dei materiali compositi per il miglioramento degli edifici in muratura", XI Congresso Nazionale "L'ingegneria Sismica in Italia", Genova, 25-29 January, 2004, CD-ROM, in italian.
- Borri A., Grazini A. (2004), "Criteri e metodologie per il dimensionamento degli interventi con FRP nel miglioramento sismico degli edifici in muratura", XI



- Congresso Nazionale “L’ingegneria Sismica in Italia”, Genova, 25-29 January, 2004, CD-ROM, in Italian.
- Casareto M., Olivieri A., Romelli A., Lagomarsino S. (2003), “Bond behavior of FRP laminates adhered to masonry”, *Advancing with Composites, Plast 2003*, Ed. I. Crivelli-Visconti, Milan, May 7-9, 2003, Milan, Italy
- Ehasani M.R., Saadatmanesh H. (1997), “Shear behavior of UMR retrofitted with FRP overlays”, *Journal of Composites for Construction*, Vol. 1, No. 1, February, 1997, pp. 17-25
- Ehasani M.R., Saadatmanesh H. (1999), “Behavior of retrofitted UMR walls under simulated earthquake loading”, *Journal of Composites for Construction*, Vol. 3, No. 3, August, 1999, pp. 134-142
- Gilstrap J.M., Dolan C.W. (1998), “Out-of-plane bending of FRP-Reinforced masonry walls”, *Composites Science and Technology*, Vol. 58, Is. 8, pp. 1277-1284
- Kuzik M.D., Elwi A.E., Cheng J.J.R. (2003), “Cyclic flexure tests of masonry walls reinforced with glass fiber reinforced polymer sheets”, *Journal of Composites for Construction*, Vol. 7, No. 1, February, 2003, pp. 20-30
- Paquette J., Bruneau M., Filiatrault A. (2001), “Out-of-plane seismic evaluation and retrofit of turn-of-the-century north American masonry walls”, *Journal of Structural Engineering*, Vol. 127, No. 5, May, 2001, pp 561-569
- Stratford T., Pascale G., Manfroni O., Bonfiglioli B. (2004), “Shear strengthening masonry panels with sheet Glass-Fiber Reinforced Polymer”, *Journal of Composites for Construction*, Vol. 8, No. 5, October 1, 2004, pp. 434-443
- Tan K.H., Patoary K.H. (2004), “Strengthening of masonry walls against out-of-plane loads using fiber-reinforced polymer reinforcement”, *Journal of Composites for Construction*, Vol. 8, No. 1, February, 2004, pp. 79-87
- Triantafillou T.C. (1998), “Composites: a new possibility for the shear strengthening of concrete, masonry and wood”, *Composites Science and Technology*, Vol. 58, Is. 8, pp. 1285-1295
- Turco, V., N. Galati, L. De Lorenzis, C. Modena and A. Nanni, “Bond Between Near Surface Mounted FRP Rods and Masonry in Structural Strengthening,” *Advancing with Composites, Plast 2003*, Ed. I. Crivelli-Visconti, Milan, May 7-9, 2003, Milan, Italy, pp. 209-217
- Turco V., Valluzzi M.R., Modena C., Nanni A. (2003), “Out-of-plane behavior of UMR walls strengthened with NSM GFRP bars”, *Int. Conf. Structural Faults + Repair 2003*, 1-3 July 2003, Commonwealth Institute, London, UK. M.C. Forde, Ed., CD-ROM version, 12 pp
- Velazquez-Dimas J.I., Ehsani M.R. (2000), “Modeling out-of-plane behavior of UMR walls retrofitted with fiber composites”, *Journal of Composites for Construction*, Vol. 4, No. 4, November, 2000, pp. 172-180
- Volnyy V.A., Pantelides C.P. (1999), “Bond length of CFRP composites attached to precast concrete walls”, *Journal of Composites for Construction*, Vol. 3, No. 4, November, 1999, pp. 168-176

## **APPENDIX I LAMINEX LEXZAR POLYUREA HEAVY- DUTY PROTECTIVE COATING / LINING: DATA SHEET**

### **A1.1 PRODUCT DESCRIPTION**

Laminex 'Lexzar' is 100% solid, no VOC (volatile organic compound), polyurea elastomeric lining especially developed for high abrasion and tear resistance, flexible with thick build up characteristics.

Laminex 'Lexzar' offers superior performance over competitive aromatic systems with enhanced UV protection, exterior durability and tenacious adhesion to metal, fiberglass, aluminum, wood (plywood, OSB, etc.), concrete and masonry.

### **A1.2 CHEMICAL FORMULATION**

100% polyurea (aromatic) with UV protection and adhesion enhancement chemical complexes. It is a two component 1:1 by volume system. The protective coating (lining) can be applied up to 500 mil thickness. (Normal application mil thickness is 50 to 250 mil.) The coating (lining) can be applied in smooth or textured non-skid finishes. 'Lexzar' aromatic polyurea formulation displays excellent chemical and environmental resistance. 'Lexzar' drastically reduces the moisture problem that causes bubbling in most polyurethane, hybrid polyurea systems.

### **A1.3 AVAILABLE COLORS**

Lexzar Black (Bondo stock,#16005B)  
Lexzar Dark Gray (Bondo stock # 16004B)  
Lexzar Medium Gray (Bondo stock #16059B)  
Lexzar Light Gray (Bondo stock #16079B)  
Lexzar White (Bondo stock #16009B)  
Lexzar Army Green (Bondo stock #16049B)  
Lexzar Part A (Activator) (Bondo stock #16005A)

### **A1.4 FEATURES**

- Excellent weathering resistance

- Higher abrasion resistance
- Because of high tangent modulus and elongation 'Lexzar' can withstand heavy traffic load and can absorb lots of stress and sudden impacts.
- Application thickness can be built up to 500 mil (1/2 inch thick). Recommended application thickness is 50 to 250 mil.
- Fast cure, dry in seconds and ready to use in 20 to 30 minutes at ambient temperatures
- An application of 1.5 to 2 mil of DiamondSheen is recommended to keep Lexzar surfaces shiny / glossy for a long time.

### **A1.5 USES**

- Protective coating / lining for floors, walls, roofs
- Textured, non-skid heavy duty coating for heavy traffic/load areas
- Protects concrete, masonry, metal and other substrates from corrosion, erosion and harsh weather
- Heavy duty, permanently elastic coating for marine docks, pillars, decks and engine compartments
- Marine splash walls
- Non-skid, abrasion resistance floor coating for utility vehicles, furniture vans, animal carriers, trailers, trucks, barns, etc.
- Anti-graffiti coating
- Anti skid coating for commercial or on site storage facilities
- Liner for secondary containments
- Retrofit/rehabilitation of old structures, buildings, bridges, etc.

### **A1.6 APPLICATION EQUIPMENT**

Laminex has developed 'Power Max' plural component (1:1 by volume) high-pressure spray equipment, stock #'s 51013 and 35004. The spray equipment is factory set for each component pumping pressures, temperature and volumetric output for optimum performance of Laminex 'Lexzar'. The spray equipment comes with 50 feet heated and insulated hoses for components A and B. The spray equipment is especially designed with many "user friendly" features such as the spray gun is designed with a special orifice, non-clogging, easy to clean features, conveniently mobile on wheels and has quick disconnect hoses.

### A1.7 APPLICATION RECOMMENDATIONS

All surfaces should be free of loose particles, dust, dirt, thermoplastic paint, oil, grease, mold release agents and other contaminants that may interfere with the adhesion process. If masking of the “area not to be painted” is required, use “wire edging tape”, stock #35317 along with masking tape. It is recommended that the product should be applied in a multi-direction (North, South, East, West) motion to help ensure proper coating thickness and cohesion. Metal, fiberglass, painted and smooth surfaces should be properly sanded and roughened. Wood boards should be dry, with no visible wetness and moisture content should not be more than 8%. Always agitate part B (colored) container to be sure that there is no settling at the bottom prior to application. Part A component is supplied in air tight drums. Please avoid air exposure, use provided desiccator at 3/4” top opening to avoid moisture contamination.

It is very important to maintain constant pressure while spraying. A variation in pressure can result in loss of properties, poor adhesion and bubbling. Part A and Part B heaters should maintain a minimum temperature of 150 deg F. The minimum temperature of Part A and Part B should be 70 deg F or higher for good pumpability and spray application.

### A1.8 PRODUCT PROPERTIES (MIXED MATERIAL):

Mixing Ratio:	1:1 by volume
Gel time at 77 deg F:	Less than 15 seconds
Tack free time (77 deg F):	Less than 60 seconds
Use time(handling time):	Less than 15 minutes
Machinable:	Less than 25 minutes
Product Usage Temp Range	-20 deg F to + 200 deg F
Application surface Temp Range:	20-135 deg F
Minimum material temperature Of part A & part B components For spray application	+ 70 deg F
Coverage per gallon Of A+B mixed:	10 mil thickness = 160.4 sq ft

25 mil thickness = 64.16 sq ft

50 mil thickness = 32 sq ft

62.25 mil thickness(1/16")=25.66 sq ft

125 mil thickness = 12.83 sq ft

250 mil thickness (1/4")= 6.41 sq ft

### A1.9 PHYSICAL PROPERTIES

Tensile Strength (PSI)	ASTM 638-01	1890 ± 200
Elongation @ break (%age)	ASTM 638-01	107 ± 25
Tangent Modulus (PSI)	ASTM 638-01	17,128 ± 1000
Tear Strength, (lbs/in) (speed = 20 in/minute)	ASTM D624-00	356 ± 25
Taber abrasion (CS-17 wheel, 1000 gram load, 1000 cycles) Weight loss in milligrams (Mg)	ASTM-D-4060-95	9.25 (Mg)
Hardness Shore D	ASTM D2240	55 ± 3
Flexibility 1/8" Mandrel	ASTM 1737	Pass
Water Absorption	ASTM D570	Less than 1.50%
Accelerated Weathering Xenon Arc Weathering, Cycle I (1000 hours)	ASTM G-155	No degradation, cracking, wrinkling or loss of adhesion. Gloss loss at the surface.
Lexzar coated with spray coat of DiamondSheen Accelerated Weathering Xenon Arc Weathering, Cycle I (1000 hours)	ASTM G-155	No gloss loss, degradation, cracking, wrinkling or loss of adhesion

**A1.10 PRODUCT SPECIFICATIONS**

Stock Number:	16005A	16005B	16004B	16049B	16059B	16079B	16009B
Description	Part A (ISO)	Part B	Part B	Part B	Part B	Part B	Part B
Physical Appearance	Clear, straw colored liquid	Black Liquid	Dark Gray Liquid	Army Green	Medium Gray	Light Gray	White
Viscosity CPS 77 deg F 1 pint can 90% full. Brookfield viscometer RVT model, Spindle #3 @ 10/20 RPM	1100 ± 150cps	550 ± 150 cps	700 ± 150 cps	600 ± 150 cps	600 ± 150 cps	550 ± 150 cps	650 ± 150 cps
Color	Should match with standard	Should match with standard	Should match with standard	Should match with standard	Should match with standard	Should match with standard	Should match with standard
WPG 77 deg F	9.5 ± 0.25	8.5 ± 0.25	8.7 ± 0.25	8.51 ± 0.25	8.6 ± 0.25	8.6 ± 0.25	8.80 ± 0.25
Specific Gravity 77 degF	1.14	1.021	1.045	1.021	1.032	1.032	1.056
Flash point of (Pensky-Martin)	+ 200 deg F	+ 200 deg F	+ 200 deg F	+ 200 deg F	+ 200 deg F	+ 200 deg F	+ 200 deg F
Shelf life in original, Sealed Containers at ambient temp	9 months	9 months	9 months	9 months	9 months	9 months	9 months
Apprx solids by weight	100%	100%	100%	100%	100%	100%	100%
Apprx solids by volume	100%	99.8%	99.8%	99.8%	99.8%	99.8%	99.8%
VOC lb/gal	0	0.01	0.01	0.01	0.01	0.01	0.01

**A1.11 CHEMICAL RESISTANCE**

ASTM D3912 Mod. 3-day immersion:

Acidic Acid (5%).....	R
Antifreeze.....	R
Brake fluid (DOT 3).....	RC
Diesel fuel.....	R
Gasoline.....	R

Hydrochloric Acid (5%).....	R
Motor Oil .....	R-Dis
Sodium Hydroxide (10%).....	R
Sulfuric Acid (10%).....	R-Dis
Transmission Fluid .....	R
JP-4 (jet fuel) .....	R
Water .....	R
Vinegar (5% water) .....	R
Sulfuric Acid 22%.....	NR
Sodium Bicarbonate .....	R

Key:

R=Recommended

R-Dis=(discoloration)

NR=Not recommended

C=Conditional-cracking ..... wash down within one hour of spillage to avoid effects

### A1.12 DIAMONDSHEEN

If it is required to preserve Lexzar glossy surface for a long time, it is recommended to apply 1.5 to 2 mil thickness spray coat of DiamondSheen within 20 minutes of application of Lexzar.

### A1.13 PACKAGING

Laminex 'Lexzar' is available in 55-gallon drums.

#### **A1.14 STORAGE**

Keep away from extreme heat, freezing and moisture. Store at 70 deg F or above in original container. If stored below 70 deg F it is recommended to warm the material to a minimum of 70 deg F before application. **DO NOT STORE MATERIAL DRUMS ON CONCRETE OR BRICK FLOORS. STORE DRUMS ON WOODEN PALLETS.**

Winter Season: It is advisable to keep the material above 70 deg F at all times. Store the material in a warmer place or use drum heaters or other sources to keep the temperature of the material above 70 deg F. Please note that warming a cold drum of material does not uniformly raise the temperature of the material. The temperature of the material in the center of the drum may be 10 to 12 deg F lower than the material along the sides of the drum.

#### **A1.15 BONDO SPRAY MAX: (SPRAY EQUIPMENT)**

Electric requirements: 208 volts, 50 amp, 50/60 Hz.....Range (200 to 240 volts),  
Single phase.

Air requirements: 50-60 CFM @ 100 PSI

Heater, part A and part B components: 3000 watts per side, total of 6000 watts

Air purging of spray gun: 8-10 CFM at 90-110 PSI

Daily start up:

- Turn on air and power supply to the machine.
- Turn on the spray hose heaters and component B stirrer at least 30 minutes prior to spraying
- Unscrew and remove side blocks on the front housing of the gun. Place separate clean containers under each individual side block. Open manual material valves on each side block simultaneously to allow trapped air to escape the hose and material to flow into the containers until all the air is purged from the material system. Close the manual valves simultaneously. Material pressure gauges on each heater should now register approximately equal pressure. If required, to equalize pressure, bleed off high pressure side by slightly opening the manual material valve on the side block over the container. Clean and lubricate side blocks and seals thoroughly and reassemble on gun. Turn, purge air and material valve on at gun.

Daily Shutdown:

Check leaking seals by turning off and on gun incoming air. If material has been purged from the gun, the seals are leaking. Turn off both material valves, trigger gun several



times. Turn off gun incoming air and trigger gun several times. If additional material is purged, the material valves are leaking.

Correct leaks by taking off black knobs and turning packaging 1/8" to 1/4" turn at a time until the leak has stopped. Recheck and inspect side blocks, side of the mixing chamber, and seals should be free of scratches, nicks or foreign material. Solvent can be used to clean it off. Use #50 drill bit to clean mixing chamber exit passage and #55 drill bit to clean the inlet side holes of the mixing chamber. Place generous amount of high quality white Lithium grease in each side of the gun front housing and on the side block seals. Reassemble the side blocks and tighten screws securely. The grease should appear at the tip of the mixing chamber. The filter screen at the feed pumps should be checked and cleaned accordingly.

#### **A1.16 PERSONAL HEALTH SAFETY, HANDLING CHEMICALS SAFETY AND HAZARDOUS WASTE DISPOSAL**

Please read and follow the cautionary statements on each product label. Please use proper eye protection, safety clothing/shoes, gloves and breathing protection during spraying and handling of this product.

#### **A1.17 BONDO HELP LINE**

Please call the technical help line at 1-800-421-2663 if you have any questions.

#### **A1.18 WARRANTY**

The technical data and any other printed information furnished by Laminex, a Division of Bondo Corporation is true and accurate to the best of our knowledge. Laminex 'Lexzar' (lining) conforms to in-house quality assurance procedures and should be considered free of defects.

Due to the wide range of applications of this product, it is impossible to assume the responsibility for any errors in regard to application, coverage, workmanship, over spray or injuries resulting from the use of this product. Laminex, a division of Bondo Corporation, makes no warranty, neither expressed nor implied, of its products and shall not be liable for indirect or consequential damage in any event.

# APPENDIX II MEC-GRID STRUCTURAL REINFORCEMENT: DATA SHEET

## A2.1 G15000 UNIDIRECTIONAL GLASS GRID

Technical Data and Use Guide



**MeC-GRID® Glass Fibre Grid for Strengthening Reinforcement**

G15000-BX1

MeC-GRID, G15000-BX1 is a high strength, unidirectional reinforcement made by bonding E glass fiber rovings with epoxy resin in a controlled factory environment.

**Features:**

- Tightly apertured, uni-directional construction
- Flexible for ease of installation
- Translucent appearance
- Strong, lightweight and durable
- Greater tensile strength than steel (by weight)
- Easy to cut and fabricate

**Applications:**

- Seismic strengthening of CMU and brick masonry walls
- General strengthening requiring uni-directional grid
- For use with 2 component polymer adhesive systems and trowelable epoxy resins
- Infrastructure repair and retrofit

**Physical Properties:**

Product Designation:	G15000-BX1
Fiber Type:	Glass
Grid Spacing (ins) (centerline to centerline):	0.437 x 0.281
Nominal Tensile (lbs/strand: warp x fill):	526 x 43
Nominal Tensile (lbs/ft):	14,400 x 1,870
Crossover Shear Strength (lbs):	Not measured
Resin Type:	Epoxy
Grid Weight (oz/sq yd):	18.2
LOI (% of resin by weight):	41
Supply Form (rolls):	40" x 500 yds
Openness of grid (% openness):	52

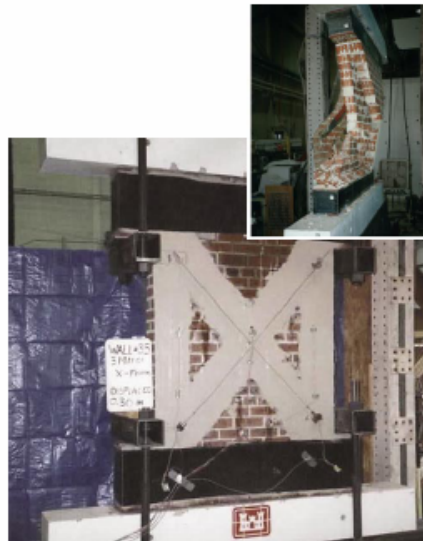

G15000-BX1 under US Army CERL testing on masonry walls

**Application Use Note:** MeC-GRID is a new material without the extensive performance history of conventional construction materials. The use of MeC-GRID in critical life, health-safety applications is not recommended until additional use experience and test data have been obtained. The use of MeC-GRID for use in fire rated applications is not recommended. MeC-GRID, like all FRP reinforcements exhibits linear elastic behavior. Accordingly, the appropriate design, safety, load, and strength reduction factors must be considered and applied for specific concrete reinforcement applications. In cases where serviceability or structural performance may be affected, the application should be reviewed and approved by a registered professional engineer. Typical physical properties as reported by the manufacturer are subject to change from time to time.

**TechFab, LLC**  
 PO Box 807 Anderson, SC 29624  
 Phone: 864 260-3355  
 Fax: 864 260-3364  
 www.techfabllc.com

In as much as TechFab, LLC has no control over installation design, installation workmanship, accessory materials, or conditions of application, TechFab, LLC does not warrant the performance or results of any installation use of MeC-GRID®. THIS WARRANTY DISCLAIMER INCLUDES ALL IMPLIED WARRANTIES, STATUTORY OR OTHERWISE, INCLUDING THE WARRANTY OF MERCHANTABILITY AND OF FITNESS FOR A PARTICULAR PURPOSE. The purchaser and/or user should perform their own tests to determine the suitability and fitness of the product for a particular purpose desired in any given situation.

MeC-GRID Glass Grid for Strengthening Reinforcement

## A2.2 G4000 BALANCED GLASS GRID

Technical Data and Use Guide



**MeC-GRID® Glass Fibre Grid for Strengthening Reinforcement**

G4000-BX1

MeC-GRID is a high performance reinforcement made by bonding E glass fiber rovings with epoxy resin in a controlled factory environment.

**Features:**

- Tightly apertured, balanced construction
- Flexible for ease of installation
- Translucent appearance
- Strong, lightweight and durable
- Greater tensile strength than steel (by weight)
- Easy to cut and fabricate

**Applications:**

- Composites
- Strengthening reinforcements
- For use with 2 component polymer adhesive systems and trowelable epoxy resins
- Automotive
- Infrastructure repair and retrofit
- Seismic upgrades

**Physical Properties:**

Product Designation:	G4000-BX1
Fiber Type:	Glass
Grid Spacing (ins) (centerline to centerline):	0.3 x 0.4
Nominal Tensile (lbs/strand; warp x fill):	556 x 401
Nominal Tensile (lbs/ft):	6,600 x 4,800
Crossover Shear Strength (lbs):	Not measured
Resin Type:	Epoxy
Grid Weight (oz/sq yd):	14
Supply Form (rolls):	40" x 500 yds

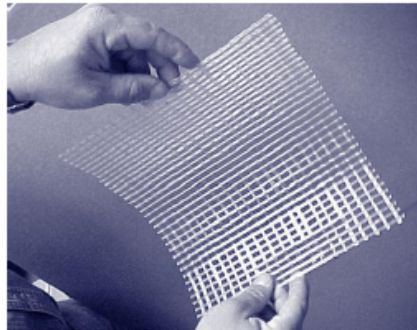

G4000-BX1 under flex

**Application Use Note:** MeC-GRID is a new material without the extensive performance history of conventional construction materials. The use of MeC-GRID in critical life, health-safety applications is not recommended until additional use experience and test data have been obtained. The use of MeC-GRID for use in fire rated applications is not recommended. MeC-GRID, like all FRP reinforcements exhibits linear elastic behavior. Accordingly, the appropriate design, safety, load, and strength reduction factors must be considered and applied for specific concrete reinforcement applications. In cases where serviceability or structural performance may be affected, the application should be reviewed and approved by a registered professional engineer. Typical physical properties as reported by the manufacturer are subject to change from time to time.

In as much as TechFab, LLC has no control over installation design, installation workmanship, accessory materials, or conditions of application, TechFab, LLC does not warrant the performance or results of any installation use of MeC-GRID®. THIS WARRANTY DISCLAIMER INCLUDES ALL IMPLIED WARRANTIES, STATUTORY OR OTHERWISE, INCLUDING THE WARRANTY OF MERCHANTABILITY AND OF FITNESS FOR A PARTICULAR PURPOSE. The purchaser and/or user should perform its own tests to determine the suitability and fitness of the product for a particular purpose desired in any given situation.

TechFab, LLC



PO Box 807    Phone: 864 260-3355  
Anderson,    Fax: 864 260-3364  
SC 29624    www.techfabllc.com

MeC-GRID Glass Grid for Strengthening Reinforcement

## APPENDIX III BOND STRENGTH AND DEVELOPMENT LENGTH

### A3.1 INTRODUCTION

The bond strength of the GGRP system used for the strengthening of an URM wall has a great influence on its structural performance. In fact, the failure due to debonding of the GGRP system from the masonry substrate can be considered as a premature brittle failure mode, which has to be avoided privileging more ductile failure modes (CNR DT, 2004).

Debonding can either start at the ends of the GGRP reinforcement (end-strip debonding), or at the mortar joints (intermediate crack debonding). Sometimes the end-strip debonding can be accompanied with a consistent removing of substrate material. Due to the natural discontinuity of the masonry, commonly the bond stresses are concentrated over a 2 - 8 in length (CNR DT, 2004).

### A3.2 BOND STRENGTH AND DEVELOPMENT LENGTH

The ultimate bond strength is computed considering a bilinear interfacial constitutive relationship ( $\tau$ -slip) as shown in Figure A-1 (CNR DT, 2004).

The maximum bond stress,  $f_{b,p}$ , can be evaluated as:

$$f_{b,p} = c_1 k_b \sqrt{f'_m f'_{tm}} \quad (\text{A.1})$$

where  $c_1$  is an experimental coefficient,  $k_b$  is a coefficient accounting for the scale effect which can be assumed equal to 1.0,  $f'_{tm}$  is the specified tensile strength of masonry.

The ultimate slip,  $s_u$ , corresponding to the complete delamination of the GGRP system (Figure A-1). The ultimate slip for Epoxy FRP systems is generally in the range 0.004 - 0.0012 in, while polyurea based systems are expected to present much higher values of  $s_u$ . More experimental work is needed to determine such bond parameters for GGRP systems.

The fracture energy,  $\Gamma_b$ , related to the delamination of the GGRP reinforcement from the masonry support can be evaluated as:

$$\Gamma_b = \frac{s_u f_{b,p}}{2} = \frac{1}{2} s_u c_1 k_b \sqrt{f'_m f'_{tm}} \quad (\text{A.2})$$

Equation A.2 assumes that the debonding of the GGRP system is localized at the masonry side.

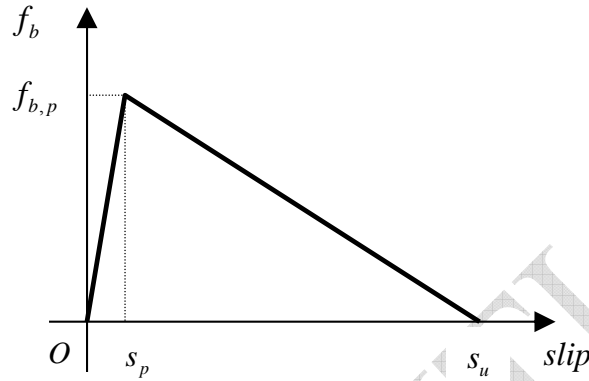

**Figure A-1: Bilinear bond stress – slip relationship**

The maximum bond strength,  $F_{b,max}$ , corresponding to an anchor length,  $l_a$ , equal or bigger than the effective length,  $l_e$ , can be evaluated as:

$$F_{b,max} = k_s w_f \sqrt{2 E_f t_f \Gamma_b} \quad (\text{A.3})$$

where  $k_s$  is a coefficient that should be experimentally determined and accounting for type of surface on which the GGRP system is applied (it usually assumes values between 0.5 and 1.0 depending on homogeneity and compactness of the substrate).  $w_f$  is the width of the GGRP strip,  $E_f$  is the modulus of elasticity of the GGRP, and  $t_f$  nominal thickness of the GGRP strip.

The optimal anchor length, which is also referred as effective adhesion length,  $l_e$ , necessary to develop the maximum bond strength,  $F_{b,max}$ , can be estimated as:

$$l_e = \sqrt{\frac{E_f t_f}{2 f'_{tm}}} \quad (\text{A.4})$$

Therefore, the maximum stress,  $f_{fe}$ , and strain,  $\varepsilon_{fe}$ , allowed in the GGRP system, taking into account the bond behavior are:

$$f_{fe} = C_E \frac{F_{b,\max}}{w_f t_f} \quad (\text{A.5})$$

$$\varepsilon_{fe} = \frac{f_{fe}}{E_f} \quad (\text{A.6})$$

where  $C_E$  is the environment reduction factor given in *Table 7-1*.

In case of anchor length,  $l_a$ , different from the effective length,  $l_e$ , the following values for  $f_{fe}$  should be taken:

$$f_{fe} = \begin{cases} C_E \frac{F_{b,\max}}{w_f t_f} \frac{l_a}{l_e} \left( 2 - \frac{l_a}{l_e} \right) & \text{if } l_a < l_e \\ C_E \frac{F_{b,\max}}{w_f t_f} & \text{if } l_a > l_e \end{cases} \quad (\text{A.7})$$

It should be noted that equations A.5 and A.6 can be used instead of equations 7.3 and 7.4 if the bond properties of the GGRP are determined experimentally for the given project.

In absence of any experimental and analytical evaluation, the anchor length should be set no less than 12 in from the cracked section or suitable anchor systems should be adopted.